

On the Functions Generated by the General Purpose Analog Computer

Olivier Bournez

École Polytechnique, LIX, 91128 Palaiseau Cedex, France

Daniel Graça

FCT, Universidade do Algarve, C. Gambelas

8005-139 Faro, Portugal

& Instituto de Telecomunicações, Lisbon, Portugal

Amaury Pouly

MPI-SWS, E1 5, Campus, 66123 Saarbrücken, Germany

& École Polytechnique, LIX, 91128 Palaiseau Cedex, France

September 29, 2017

Abstract

We consider the General Purpose Analog Computer (GPAC), introduced by Claude Shannon in 1941 as a mathematical model of Differential Analysers, that is to say as a model of continuous-time analog machines.

The GPAC generates as output univariate functions (i.e. functions $f : \mathbb{R} \rightarrow \mathbb{R}$). In this paper we extend this model by: (i) allowing multivariate functions (i.e. functions $f : \mathbb{R}^n \rightarrow \mathbb{R}^m$); (ii) introducing a notion of amount of resources (space) needed to generate a function, which allows the stratification of GPAC generable functions into proper subclasses. We also prove that a wide class of (continuous and discontinuous) functions can be uniformly approximated over their full domain.

We prove a few stability properties of this model taking into account the amount of resources needed to perform each operation.

We establish that generable functions are always analytic but that they can nonetheless (uniformly) approximate a wide range of nonanalytic functions.

1 Introduction

In 1941, Claude Shannon introduced in [Sha41] the GPAC model as a model for the Differential Analyzer [Bus31], which are mechanical (and later on electronics) continuous time analog machines, on which he worked as an operator. The model was later refined in [PE74], [GC03]. Originally it was presented as a model based on circuits. Basically, a GPAC is any circuit that can be build from the 4 basic units of Figure 1, that is to say from basic units realizing constants, additions, multiplications and integrations, all of them working

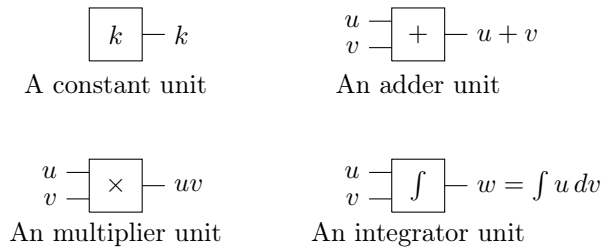

Figure 1: Circuit presentation of the GPAC: a circuit built from basic units. Presentation of the 4 types of units: constant, adder, multiplier, and integrator.

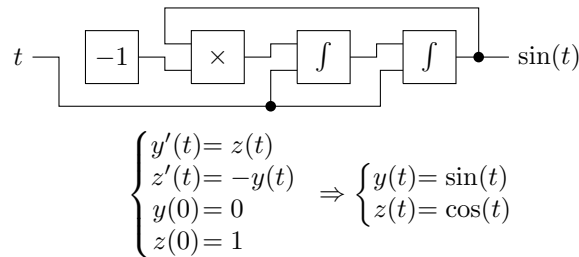

Figure 2: Example of GPAC circuit: computing sine and cosine with two variables

over analog real quantities (that were corresponding to angles in the mechanical Differential Analysers, and later on to voltage in the electronic versions).

Figure 2 illustrates for example how the sine function can be generated using two integrators, with suitable initial state, as being the solution of ordinary differential equation

$$\begin{cases} y'(t) = z(t) \\ z'(t) = -y(t) \end{cases}$$

with suitable initial conditions.

The original GPAC model introduced by Shannon has the feature that it works in *real time*: for example if the input t is updated in the GPAC circuit of Figure 2, then the output is immediately updated for the corresponding value of t .

Shannon himself realized that functions computed by a GPAC are nothing more than solutions of a special class of polynomial differential equations. In particular it can be shown that a function $f : \mathbb{R} \rightarrow \mathbb{R}$ is computed by Shannon's model [Sha41], [GC03] if and only if it is a (component of the) solution of a polynomial initial value problem of the form

$$\begin{cases} y'(t) = p(y(t)) \\ y(t_0) = y_0 \end{cases} \quad t \in \mathbb{R} \quad (1)$$

where p is a vector of polynomials and $y(t)$ is vector. In other words, $f(t) = y_1(t)$, and $y'_i(t) = p_i(y(t))$ where p_i is a multivariate polynomial.

Basically, the idea is just to introduce a variable for each output of a basic unit, and write the corresponding ordinary differential equation (ODE), and observe that it can be written as an ODE with a polynomial right hand side.

Remark 1 *Technically speaking, the initial model studied by Claude Shannon in [Sha41] suffers from problems of being sometimes not fully formally defined and some key proofs in that paper contained imprecisions. This has been observed and refined later in several papers in particular in [PE74] in order to get to a model where the result of Shannon stating the equivalence of computable functions with differentially algebraic functions precisely hold. However, the paper [PE74] had the problem that the GPAC model it presented had no direct connection to circuits built using the units of Figure 1, and therefore seemed to lack the physical resemblance to Differential analysers (see [GC03] for a discussion). In the paper [GC03] these problems are solved by formally defining rules to get allowable GPAC circuits (removing bizarre possibilities that could happen in Shannon’s original model like linking the output of an adder unit to one of its inputs) which ensure that each GPAC circuit has one or more outputs, which exist and are unique. Moreover, the GPAC defined as in [GC03] seems to capture all the functions computed by the original model of Shannon and it is shown there that all outputs of a GPAC satisfy Equation (1). The GPAC model of [GC03] was further refined in [Gra04], where a simpler structure of the GPAC circuits is shown to be equivalent to that presented in [GC03].*

Here, we consider the formal, nice and clear definition of [GC03] of GPACs, and for this class there is a clear equivalence between GPACs and polynomial initial value problems of the form (1).

We say that a function $f : \mathbb{R} \rightarrow \mathbb{R}$ is generable (by a GPAC) if and only if it corresponds to some component of a solution of such a polynomial initial value problem (1).

The discussion on how to go from univariate to multivariate functions, that is to say from functions $f : \mathbb{R} \rightarrow \mathbb{R}^m$ to functions $f : \mathbb{R}^n \rightarrow \mathbb{R}^m$ is briefly discussed in [Sha41], but no clear definitions and results for this case have been stated or proved previously, up to our knowledge. This is the purpose of the current paper. Another objective of this paper is to introduce basic measures of the resources used by a GPAC (in particular on the growth of functions), which might be used in the future to establish complexity results for functions generated with GPACs.

We introduce the notion of *generable* functions which are solutions of a polynomial initial-value problem (PIVP) defined with an ODE (1), and generalize this notion to several input variables. We prove that this class enjoys a number of stability and robustness properties.

Notice that extending the GPAC model to deal with several variables have also been considered in [PZ17]: Analog networks on function data streams are considered, and their semantic is obtained as the fixed point of suitable operators on continuous data streams. A characterization of generable functions generalizing some of Shannon’s results is also provided.

The work we present here is different in the sense that we are interested in measuring resources used in the GPAC and that we try to stay as close to the original GPAC as possible (e.g. we do not introduce new types of units or of data as done in [PZ17]).

The paper is organized as follows:

- Section 2 will introduce the notion of *generable* function, in the unidimensional and multidimensional case.
- Section 3 will give some stability properties of the class of generable functions, mostly stability by arithmetic operations, composition and ODE solving.
- Section 4 will show that generable functions are always analytic
- Section 5 will give a list of useful generable functions, as a way to see what can be achieved with generable functions. In particular, we prove that a wide class of functions (including piecewise defined functions, or periodic functions) can be uniformly approximated over their domain. Notice that Shannon proved a similar result but only over a compact domain (using basically Weierstrass's theorem) and for dimension 1. Here, unlike Shannon, we prove a uniform approximation (distance can be controlled and set arbitrary small), and over the full domain of the functions (not only over compact domains).
- Section 6 will discuss the issue of constants. We give a few properties of *generable fields* which are fields with an extra property related to generable functions, used in the previous proofs, and we prove basically that constants can always be chosen to be polynomial time computable numbers.

The current paper is mainly based on some extensions of results present in the chapter 2 of the PhD document of Amaury Pouly¹ [Pou15]. This PhD was defended on July 2015, but presented results are original and have not been published otherwise. Furthermore, we go further here than what is established in Chapter 2 of this PhD document.

Some results of this paper are already stated, without proofs in [BGP16], with a reference pointing to a preprint which ultimately would lead to the current paper. The difference between the two papers is that this paper focus on the class of *generable functions* by GPACs, while [BGP16] focus on the class of *computable functions* by GPACs (see [BCGH07] for an overview of the distinction between generable and computable functions by a GPAC. The work presented in this paper and in [BGP16] extends earlier results present in [BCGH07] by considering the multivariate case and complexity). The class of generable functions is discussed in detail here and many properties are proved (stability by several operations, analyticity, existence of a strict hierarchy of subclasses, etc.) and several functions and techniques which can be used for “analog programming” are introduced. We also consider the amount of resources used by a GPAC to perform several operations involving generable functions.

The paper [BGP16] by its turn focus on the class of computable functions by a GPAC, which are defined with the use of generable functions, hence the need to cite several results about generable functions which are proved here. In [BGP16] we show that the class of computable functions is well defined (and that we can take into account bounded resources) and that several different (yet intuitive) notions of computability for the GPAC all yield the same class of functions, showing that a well-defined class of computable functions exists for the GPAC, even if we restrict the resources used by a GPAC.

¹<https://pastel.archives-ouvertes.fr/te1-01223284>

1.1 Notations

In this paper, \mathbb{R} denotes the real numbers, $\mathbb{R}_{\geq 0} = [0, +\infty)$ the nonnegative real numbers, $\mathbb{N} = \{0, 1, 2, \dots\}$ the natural numbers, \mathbb{Z} the integers, $\llbracket a, b \rrbracket = \{a, a+1, \dots, b\}$ the integers between a and b , \mathbb{Q} the rational numbers, \mathbb{R}_P the polynomial time computable real numbers [Ko91], \mathbb{R}_G the smallest generable field (see Section 6). $M_{n,d}(\mathbb{K})$ denotes the set of $n \times d$ matrices over the ring \mathbb{K} . For any set X , $\mathcal{P}(X)$ denotes the powerset of X and $\#X$ the cardinal of X . For any function f , $\text{dom } f$ is the domain of f , $f^{[n]}$ the n^{th} iterate of f , $f \upharpoonright_X$ the restriction of f to X , $J_f(x)$ denotes the Jacobian matrix of f at x . For any vector $y \in \mathbb{R}^n$ and $e \leq n$, $y_{1..e} = (y_1, \dots, y_e)$ denotes the first e components of y and $\|y\| = \max(|y_1|, \dots, |y_n|)$ denotes the infinity norm. For any $x_0 \in \mathbb{R}^n$ and $r > 0$, $B_r(x_0) = \{x : \|x - x_0\|_2 < r\}$ denotes the open of radius r and center p for the euclidean norm. Given a (multivariate) polynomial p , $\text{deg}(p)$ denotes its degree and Σp the sum of the absolute value of its coefficients. We denote by $\mathbb{K}[\mathbb{R}^d]$ the set of polynomial functions in d variables with coefficients in \mathbb{K} . Given a vector of polynomial $p = (p_1, \dots, p_k)$, which we simply refer to as a polynomial, $\text{deg}(p) = \max(\text{deg}(p_1), \dots, \text{deg}(p_k))$ and $\Sigma p = \max(\Sigma p_1, \dots, \Sigma p_k)$. We denote by $\mathbb{K}^k[\mathbb{R}^d]$ the set of vectors of polynomial functions in d variables of size k with coefficients in \mathbb{K} . In this article, we write *poly* to denote an unspecified polynomial. For any $x \in \mathbb{R}$, $\text{sgn}(x)$ denotes the sign of x , $\lfloor x \rfloor$ the integer part of x , $\text{int}_k(x) = \max(0, \min(k, \lfloor x \rfloor))$, $\lceil x \rceil$ the nearest integer (undefined for $n + \frac{1}{2}$).

2 Generable functions

In this section, we will define a notion of function generated by a PIVP. From previous discussions, they correspond to functions generated by the General Purpose Analog Computers of Claude Shannon [Sha41];

This class of functions is closed by a number of natural operations such as arithmetic operators or composition. In particular, we will see that those functions are always analytic. The major property of this class is the stability by ODE solving: if f is *generable* and y satisfies $y' = f(y)$ then y is generable. This means that we can design differential systems where the right-hand side contains much more general functions than polynomials, and this system can be rewritten to use polynomials only.

Several of the results here are extensions to the multidimensional case of results established in [Gra07]. Moreover, a noticeable difference is that here we are also talking about complexity, whereas [Gra07] is often not precise about the growth of functions as only motivated by computability theory.

In this section, \mathbb{K} will always refer to a real field, for example $\mathbb{K} = \mathbb{Q}$. The basic definitions work for any such field but the main results will require some assumptions on \mathbb{K} . These assumptions will be formalized in Definition 9 and detailed in Section 6.

2.1 Unidimensional case

We start with the definition of generable functions from \mathbb{R} to \mathbb{R}^n . Those are defined as the solution of some polynomial IVP (PIVP) with an additional boundedness constraint. This will be of course key to talk about complexity theory for the GPAC, since if no constraint is put on the growth of functions, it

is easy to see that arbitrary growing functions can be generated by a GPAC (or, equivalently, by a PIVP), such as the $t \mapsto \exp(\exp(\dots \exp(t)))$ function. Indeed consider the following system

$$\begin{cases} y_1(0)=1 \\ y_2(0)=1 \\ \dots \\ y_n(0)=1 \end{cases} \quad \begin{cases} y_1'(t)=y_1(t) \\ y_2(t)=y_1(t)y_2(t) \\ \dots \\ y_d'(t)=y_1(t)\cdots y_n(t) \end{cases}$$

This system has the form (1) and can be solved explicitly. It has the following solution:

$$y_1(t) = e^t \quad y_{n+1}(t) = e^{y_n(t)-1} \quad y_d(t) = e^{e^{\dots e^{e^t}-1}-1}$$

Hence, although previous papers about the GPAC studied computability, like [Sha41], [PE74], [GC03] or [Gra04], they said nothing about complexity. And as the previous example shows, the output of a GPAC can have an arbitrarily high growth and thus arbitrarily high complexity. Hence, to distinguish between reasonable GPACs, it is natural to bound the growth of the outputs of a GPAC and use those bounds as a complexity measure. Moreover, as we have shown in [BGP12], we can compute (in the Computable Analysis setting [BHW08]) the solution of a PIVP in time polynomial in the growth bound of the PIVP. This motivates the following definition (in what follows, $\mathbb{K}[\mathbb{R}^n]$ denotes polynomial functions with n variables and with coefficients in \mathbb{K} , where variables live in \mathbb{R}^n and² $\mathbb{R}_{\geq 0} = [0, +\infty[$):

Definition 2 (Generable function) *Let $\mathbf{sp} : \mathbb{R}_{\geq 0} \rightarrow \mathbb{R}_{\geq 0}$ be a nondecreasing function and $f : \mathbb{R} \rightarrow \mathbb{R}^m$. We say that $f \in \text{GVAL}_{\mathbb{K}}[\mathbf{sp}]$ if and only if there exists $n \geq m$, $y_0 \in \mathbb{K}^n$ and $p \in \mathbb{K}^n[\mathbb{R}^n]$ such that there is a (unique) $y : \mathbb{R} \rightarrow \mathbb{R}^n$ satisfying for all time $t \in \mathbb{R}$:*

- $y'(t) = p(y(t))$ and $y(0) = y_0$ ▶ y satisfies a differential equation
- $f(t) = y_{1..m}(t) = (y_1(t), \dots, y_m(t))$ ▶ f is a component of y
- $\|y(t)\| \leq \mathbf{sp}(|t|)$ ▶ y is bounded by \mathbf{sp}

The set of all generable functions is denoted by $\text{GVAL}_{\mathbb{K}} = \bigcup_{\mathbf{sp}:\mathbb{R} \rightarrow \mathbb{R}_{\geq 0}} \text{GVAL}_{\mathbb{K}}[\mathbf{sp}]$. When this is not ambiguous, we do not specify the field \mathbb{K} and write $\text{GVAL}[\mathbf{sp}]$ or simply GVAL . We will also write $\text{GVAL}[\text{poly}]$ (or $\text{GVAL}_{\mathbb{K}}[\text{poly}]$) as a synonym of $\text{GVAL}[\mathbf{sp}]$ (respectively: $\text{GVAL}_{\mathbb{K}}[\mathbf{sp}]$) for some polynomial \mathbf{sp} (see coming Remark 27).

Remark 3 (Uniqueness) *The uniqueness of y in Definition 2 is a consequence of the Cauchy-Lipschitz theorem. Indeed a polynomial is a locally Lipschitz function.*

Remark 4 (Regularity) *As a consequence of the Cauchy-Lipschitz theorem, the solution y in Definition 2 is at least C^∞ . It can be seen that it is in fact real analytic, as it is the case for analytic differential equations in general [Arn78].*

²We write $[a, b]$ (respectively: $]a, b[$, $[a, b[$, $]a, b]$) for closed (resp. semi-closed, open) interval.

Remark 5 (Multidimensional output) *It should be noted that although Definition 2 defines generable functions with output in \mathbb{R}^m , it is completely equivalent to say that f is generable if and only if each of its component is (i.e. f_i is generable for every i); and restrict the previous definition to functions from \mathbb{R} to \mathbb{R} only. Also note that if y is the solution from Definition 2, then obviously y is generable.*

Although this might not be obvious at first glance, this class contains polynomials, and contains many elementary functions such as the exponential function, as well as the trigonometric functions. Intuitively, all functions in this class can be computed efficiently by classical machines, where \mathbf{sp} measures some “hardness” in computing the function. We took care to choose the constants such as the initial time and value, and the coefficients of the polynomial in \mathbb{K} . The idea is to prevent any uncomputability from arising by the choice of uncomputable real numbers in the constants.

Example 6 (Polynomials are generable) *Let p in $\mathbb{Q}(\pi)[\mathbb{R}]$. For example $p(x) = x^7 - 14x^3 + \pi^2$. We will show that $p \in \text{GVAL}_{\mathbb{K}}[\mathbf{sp}]$ where $\mathbf{sp}(x) = x^7 + 14x^3 + \pi^2$. We need to rewrite p with a polynomial differential equation: we immediately get that $p(0) = \pi^2$ and $p'(x) = 7x^6 - 42x^2$. However, we cannot express $p'(x)$ as a polynomial of $p(x)$ only: we need access to x . This can be done by introducing a new variable $v(x)$ such that $v(x) = x$. Indeed, $v'(x) = 1$ and $v(0) = 0$. Finally we get:*

$$\begin{cases} p(0) = \pi^2 \\ p'(x) = 7v(x)^6 - 42v(x)^2 \end{cases} \quad \begin{cases} v(0) = 0 \\ v'(x) = 1 \end{cases}$$

Formally, we define $y(x) = (p(x), x)$ and show that $y(0) = (\pi^2, 0) \in \mathbb{K}^2$ and $y'(x) = p'(y(x))$ where $p_1(a, b) = 7b^6 - 42b^2$ and $p_2(a, b) = 1$. Also note that the coefficients are clearly in $\mathbb{Q}(\pi)$. We also need to check that \mathbf{sp} is a bound on $\|y(x)\|$ (for $x \geq 0$):

$$\|y(x)\| = \max(|x|, |x^7 - 14x^3 + \pi^2|) \leq \mathbf{sp}(x)$$

This shows that $p \in \text{GVAL}_{\mathbb{K}}[\mathbf{sp}]$ and can be generalized to show that any polynomial in one variable is generable.

Example 7 (Some generable elementary functions) *We will check that $\exp \in \text{GVAL}_{\mathbb{Q}}[\exp]$ and $\sin, \cos, \tanh \in \text{GVAL}_{\mathbb{Q}}[x \mapsto 1]$. We will also check that $\arctan \in \text{GVAL}_{\mathbb{Q}}[x \mapsto \max(x, \frac{\pi}{2})]$.*

- *A characterization of the exponential function is the following: $\exp(0) = 1$ and $\exp' = \exp$. Since $\|\exp\| = \exp$, it is immediate that $\exp \in \text{GVAL}_{\mathbb{Q}}[\exp]$. The exponential function might be the simplest generable function.*
- *The sine and cosine functions are related by their derivatives since $\sin' = \cos$ and $\cos' = -\sin$. Also $\sin(0) = 0$ and $\cos(0) = 1$, and $\|(\sin(x), \cos(x))\| \leq 1$, we get that $\sin, \cos \in \text{GVAL}_{\mathbb{Q}}[x \mapsto 1]$ with the same system.*
- *The hyperbolic tangent function will be very useful in this paper. Is it known to satisfy the very simple polynomial differential equation $\tanh' = 1 - \tanh^2$. Since $\tanh(0) = 0$ and $|\tanh(x)| \leq 1$, this shows that $\tanh \in \text{GVAL}_{\mathbb{Q}}[x \mapsto 1]$.*

- Another very useful function will be the arctangent function. A possible definition of the arctangent is the unique function satisfying $\arctan(0) = 0$ and $\arctan'(x) = \frac{1}{1+x^2}$. Unfortunately this is neither a polynomial in $\arctan(x)$ nor in x . A common trick is to introduce a new variable $z(x) = \frac{1}{1+x^2}$ so that $\arctan'(x) = z(x)$, in the hope that z satisfies a PIVP. This is the case since $z(0) = 1$ and $z'(x) = \frac{-2x}{(1+x^2)^2} = -2xz(x)^2$ which is a polynomial in z and x . We introduce a new variable for x as we did in the previous examples. Finally, define $y(x) = (\arctan(x), \frac{1}{1+x^2}, x)$ and check that $y(0) = (0, 1, 0)$ and $y'(x) = (y_2(x), -2y_3(x)y_2(x)^2, 1)$. The $\frac{\pi}{2}$ bound on \arctan is a textbook property, and the bound on the other variables is immediate.

Not only the class of generable functions contains many classical and useful functions, but it is also closed under many operations. We will see that the sum, difference, product and composition of generable functions are still generable. Before moving on to the properties of this class, we need to mention the easily overlooked issue about constants, best illustrated as an example.

Example 8 (The issue of constants) Let \mathbb{K} be a field, containing at least the rational numbers. Assume that generable functions are closed under composition, that is for any two $f, g \in \text{GVAL}_{\mathbb{K}}$ we have $f \circ g \in \text{GVAL}_{\mathbb{K}}$. Let $\alpha \in \mathbb{K}$ and $g = x \mapsto \alpha$. Then for any $(f : \mathbb{R} \rightarrow \mathbb{R}) \in \text{GVAL}_{\mathbb{K}}$, $f \circ g \in \text{GVAL}_{\mathbb{K}}$. Using Definition 2, we get that $f(g(0)) \in \mathbb{K}$ which means $f(\alpha) \in \mathbb{K}$ for any $\alpha \in \mathbb{K}$. In other words, \mathbb{K} must satisfy the following property:

$$f(\mathbb{K}) \subseteq \mathbb{K} \quad \forall f \in \text{GVAL}_{\mathbb{K}}$$

This property does not hold for general fields.

The example above outlines the need for a stronger hypothesis on \mathbb{K} if we want to be able to compose functions. Motivated by this example, we introduce the following notion of *generable field*.

Definition 9 (Generable field) A field \mathbb{K} is generable if and only if $\mathbb{Q} \subseteq \mathbb{K}$ and for any $\alpha \in \mathbb{K}$ and $(f : \mathbb{R} \rightarrow \mathbb{R}) \in \text{GVAL}_{\mathbb{K}}$, we have $f(\alpha) \in \mathbb{K}$.

 From now on, we will assume that \mathbb{K} is a generable field. See Section 6 for more details on this assumption.

Example 10 (Usual constants are generable) In this paper, we will use again and again that some well-known constants belong to any generable field. We detail the proof for π and e :

- It is well-known that $\frac{\pi}{4} = \arctan(1)$. We saw in Example 7 that $\arctan \in \text{GVAL}_{\mathbb{Q}}$ and since $1 \in \mathbb{K}$ we get that $\frac{\pi}{4} \in \mathbb{K}$ because \mathbb{K} is a generable field. We conclude that $\pi \in \mathbb{K}$ because \mathbb{K} is a field and $4 \in \mathbb{K}$.
- By definition, $e = \exp(1)$ and $\exp \in \text{GVAL}_{\mathbb{Q}}$, so $e \in \mathbb{K}$ because \mathbb{K} is a generable field and $1 \in \mathbb{K}$.

Lemma 11 (Arithmetic on generable functions) Let $f \in \text{GVAL}[\text{sp}]$ and $g \in \text{GVAL}[\overline{\text{sp}}]$.

- $f + g, f - g \in \text{GVAL}[\text{sp} + \overline{\text{sp}}]$
- $fg \in \text{GVAL}[\max(\text{sp}, \overline{\text{sp}}, \text{sp} \overline{\text{sp}})]$
- $\frac{1}{f} \in \text{GVAL}[\max(\text{sp}, \text{sp}')] \text{ where } \text{sp}'(t) = \frac{1}{|f(t)|}, \text{ if } f \text{ never cancels}$
- $f \circ g \in \text{GVAL}[\max(\overline{\text{sp}}, \text{sp} \circ \overline{\text{sp}})]$

Note that the first three items only require that \mathbb{K} is a field, whereas the last item also requires \mathbb{K} to be a generable field.

Proof. Assume that $f : \mathbb{R} \rightarrow \mathbb{R}^m$ and $g : \mathbb{R} \rightarrow \mathbb{R}^\ell$. We will make a detailed proof of the product and composition cases, since the sum and difference are much simpler. The intuition follows from basic differential calculus and the chain rule: $(fg)' = f'g + fg'$ and $(f \circ g)' = g'(f' \circ g)$. Note that $\ell = 1$ for the composition to make sense and $\ell = m$ for the product to make sense (componentwise). The only difficulty in this proof is technical: the differential equation may include more variables than just the ones computing f and g . This requires a bit of notation to stay formal. Apply Definition 2 to f and g to get $p, \overline{p}, y_0, \overline{y}_0$. Consider the following systems:

$$\begin{cases} y(0) = y_0 \\ y'(t) = p(y(t)) \\ \overline{y}(0) = \overline{y}_0 \\ \overline{y}'(t) = \overline{p}(\overline{y}(t)) \end{cases} \quad \begin{cases} z_i(0) = y_{0,i} \overline{y}_{0,i} \\ z'_i(t) = p_i(y(t)) \overline{y}_i(t) + y_i(t) \overline{p}_i(\overline{y}(t)) \\ u_i(0) = f_i(\overline{y}_{0,1}) \\ u'_i(t) = \overline{p}_i(\overline{y}(t)) p(u(t)) \end{cases} \quad i \in \llbracket 1, m \rrbracket$$

Those systems are clearly polynomial. By construction, u and z exist over \mathbb{R} since $z_i(t) = y_i(t) \overline{y}_i(t)$ satisfies the differential equation over \mathbb{R} (indeed y and \overline{y} exist over \mathbb{R}). Similarly, $u_i(t) = y_i(\overline{y}(t))$ exists over \mathbb{R} and satisfies the equation. Remember that by definition, for any $i \in \llbracket 1, m \rrbracket$ and $j \in \llbracket 1, \ell \rrbracket$, $f_i(t) = y_i(t)$ and $g_j(t) = z_j(t)$. Consequently, $z_i(t) = f_i(t) g_i(t)$ and $u_i(t) = f_i(g_1(t))$.

Also by definition, $\|y(t)\| \leq \text{sp}(t)$ and $\|\overline{y}(t)\| \leq \overline{\text{sp}}(t)$. It follows that $|z_i(t)| \leq |y_i(t)| |\overline{y}_i(t)| \leq \text{sp}(t) \overline{\text{sp}}(t)$, and similarly we have $|u_i(t)| \leq |f_i(g_1(t))| \leq \text{sp}(g_1(t)) \leq \text{sp}(\overline{\text{sp}}(t))$.

The case of $\frac{1}{g}$ is very similar: define $g = \frac{1}{f}$ then $g' = -f'g^2$. The only difference is that we don't have an a priori bound on g except $\frac{1}{|f|}$, and we must assume that f is never zero for g to be defined over \mathbb{R} .

Finally, a very important note about constants and coefficients which appear in those systems. It is clear that $y_{0,i} \overline{y}_{0,i} \in \mathbb{K}$ because \mathbb{K} is a field. Similarly, for $\frac{1}{f}$ we have $\frac{1}{f(0)} = \frac{1}{y_{0,1}} \in \mathbb{K}$. However, there is no reason in general for $f_i(\overline{y}_{0,1})$ to belong to \mathbb{K} , and this is where we need the assumption that \mathbb{K} is generable. ■

2.2 Multidimensional case

We introduced generable functions as a special kind of function from \mathbb{R} to \mathbb{R}^n . We saw that this class nicely contains polynomials, however it comes with two defects which prevents other interesting functions from being generable:

- The domain of definition is \mathbb{R} : this is very strong, since other “easy” targets such as \tan , \log or even $x \mapsto \frac{1}{x}$ cannot be defined, despite satisfying polynomial differential equations.

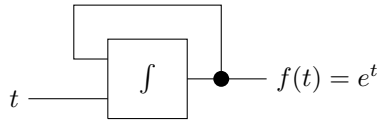

Figure 3: Simple GPAC

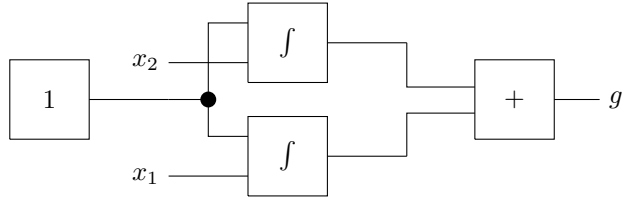

Figure 4: GPAC with two inputs

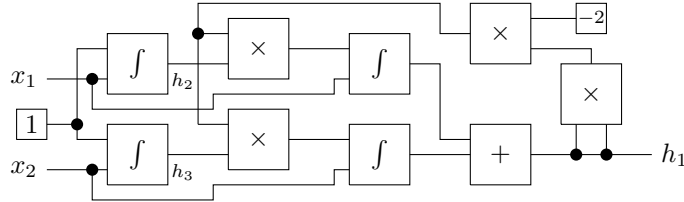

Figure 5: A more involved multidimensional GPAC

- The domain of definition is one-dimensional: it would be useful to define generable functions in several variables, like multivariate polynomials.

The first issue can be dealt with by adding restrictions on the domain where the differential equation holds, and by shifting the initial condition (0 might not belong to the domain). Overcoming the second problem is less obvious.

The examples below give two intuitions before introducing the formal definition. The first example draws inspiration from multivariate calculus and differential form theory. The second example focuses on GPAC composition. As we will see, both examples highlight the same properties of multidimensional generable functions.

Example 12 (Multidimensional GPAC) *The history and motivation for the GPAC have been described above. The GPAC is the starting point for the definition of generable functions. It crucially relies on the integrator unit to build interesting circuits. In modern terms, the integration is often done implicitly with respect to time, as shown in Figure 3 where the corresponding equation is $f(t) = \int f$, or $f' = f$. Notice that the circuit has a single “floating input” which is t and is only used in the “derivative port” of the integrator. What would be the meaning of a circuit with several such inputs, as shown in Figure 4? Formally writing the system and differentiating gives:*

$$g = \int 1dx_1 + \int 1dx_2 = x_1 + x_2$$

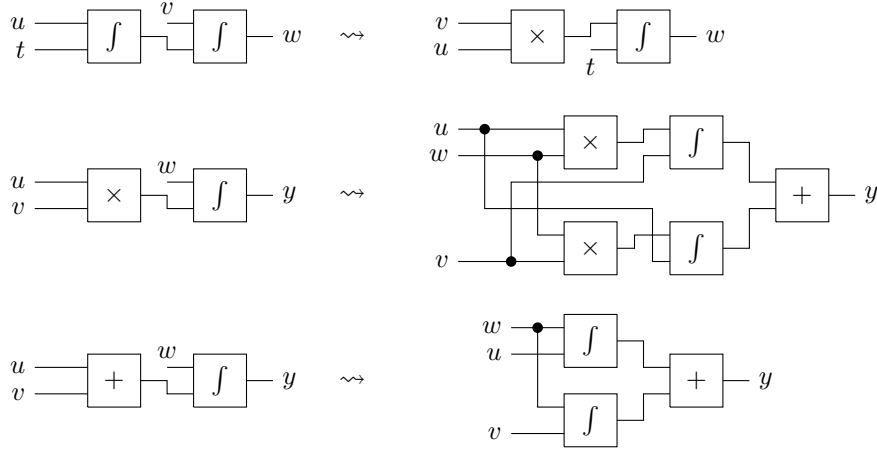

Figure 6: GPAC rewriting

$$dg = dx_1 + dx_2$$

Figure 5 gives a more interesting example to better grasp the features of these GPAC. Using the same “trick” as before we get:

$$\begin{aligned} h_2 &= \int 1 dx_1 & dh_2 &= dx_1 \\ h_3 &= \int 1 dx_2 & dh_3 &= dx_2 \\ h_1 &= \int -2h_1^2 h_2 dx_1 + \int -2h_1^2 h_3 dx_2 & dh_1 &= -2h_1^2 h_2 dx_1 - 2h_1^2 h_3 dx_2 \end{aligned}$$

It is now apparent that the computed function h satisfies a special property because $dh_1(x) = p_1(h_1, h_2, h_3)dx_1 + p_2(h_1, h_2, h_3)dx_2$ where p_1 and p_2 are polynomials. In other words, $dh_1 = p(h) \cdot dx$ where $h = (h_1, h_2, h_3)$, $x = (x_1, x_2)$ and $p = (p_1, p_2)$ is a polynomial vector. We obtain similar equations for h_2 and h_3 . Finally, $dh = q(h)dx$ where $q(h)$ is the polynomial matrix given by:

$$q(h) = \begin{pmatrix} -2h_1^2 h_2 & -2h_1^2 h_3 \\ 1 & 0 \\ 0 & 1 \end{pmatrix}$$

This can be equivalently stated as $J_h = q(h)$. This is a generalization of PIVP to polynomial partial differential equations.

To complete this example, note that it can be solved exactly and $h_1(x_1, x_2) = \frac{1}{x_1^2 + x_2^2}$ which is defined over $\mathbb{R}^2 \setminus \{(0, 0)\}$.

Example 13 (GPAC composition) Another way to look at Figure 5 and Figure 4 is to imagine that $x_1 = X_1(t)$ and $x_2 = X_2(t)$ are functions of the time (produced by other GPACs), and rewrite the system in the time domain with $h = H(t)$:

$$\begin{aligned} H_2'(t) &= X_1'(t) \\ H_3'(t) &= X_2'(t) \\ H_1'(t) &= -2H_1(t)^2 H_2(t) X_1'(t) - 2H_1(t)^2 H_3(t) X_2'(t) \end{aligned}$$

We obtain a system similar to the unidimensional PIVP: for a given choice of X we have $H'(t) = q(H(t))X'(t)$ where $q(h)$ is the polynomial matrix given by:

$$q(h) = \begin{pmatrix} -2h_1^2h_2 & -2h_1^2h_3 \\ 1 & 0 \\ 0 & 1 \end{pmatrix}$$

Note that this is the same polynomial matrix as in the previous example. The relationship between the time domain H and the original h is simply given by $H(t) = h(x(t))$. This approach has a natural interpretation on the GPAC circuit in terms of circuit rewriting. Assume that x_1 and x_2 are the outputs of two GPACs (with input t), i.e. $x_1 = x_1(t)$ and $x_2 = x_2(t)$. Then x_1, x_2 are given by the first two components of a polynomial ODE (1), i.e. $x_1(t) = y_1(t)$ and $x_2(t) = y_2(t)$. Moreover one has $x_1'(t) = p_1(y), x_2'(t) = p_2(y)$. That means that the output $H(t) = (H_1(t), H_2(t), H_3(t))$ of the GPAC of Figure 5 satisfies

$$H'(t) = q(H(t))X'(t) = q(H(t))(p_1(y), p_2(y))$$

and therefore consists of the first three components of the polynomial ODE given by

$$\begin{aligned} H' &= q(H(t))(p_1(y), p_2(y)) \\ y' &= p(y) \end{aligned}$$

Thus, if x_1 and x_2 are the outputs of the some GPACs, depending on one input t , and if we connect the outputs of these two GPACs to the inputs of the two-dimensional GPAC of Figure 5, we obtain a one-input GPAC computing $H(t)$, where t is the input. Note that in a normal GPAC, the time t is the only valid input of the derivative port of the integrator, so we need to rewrite integrators which violate this rule. This can be done by rewriting the ODE defining $H(t)$ into a polynomial ODE as done above, and then by implementing a GPAC which computes the solution of this ODE such that the time t is the only valid input of the derivative port of each integrator (this is trivial to implement). This procedure always stops in finite time. Moreover it always works as long as $q(\cdot)$ is a matrix consisting of polynomials.

These considerations lead to state that the following generalization is clearly the one we want:

Definition 14 (Generable function) Let $d, \ell \in \mathbb{N}$, I an open and connected subset of \mathbb{R}^d , $\text{sp} : \mathbb{R}_{\geq 0} \rightarrow \mathbb{R}_{\geq 0}$ a nondecreasing function and $f : I \rightarrow \mathbb{R}^\ell$. We say that $f \in \text{GVAL}_{\mathbb{K}}[\text{sp}]$ if and only if there exists $n \geq \ell$, $p \in M_{n,d}(\mathbb{K})[\mathbb{R}^n]$, $x_0 \in (\mathbb{K}^d \cap I)$, $y_0 \in \mathbb{K}^n$ and $y : I \rightarrow \mathbb{R}^n$ satisfying for all $x \in I$:

- $y(x_0) = y_0$ and $J_y(x) = p(y(x))$ (i.e. $\partial_j y_i(x) = p_{ij}(y(x))$) \blacktriangleright y satisfies a differential equation
- $f(x) = y_{1..\ell}(x)$ \blacktriangleright f is a component of y
- $\|y(x)\| \leq \text{sp}(\|x\|)$ \blacktriangleright y is bounded by sp

Remark 15 (Uniqueness) The uniqueness of y in Definition 14 can be seen in two different ways: by uniqueness of the unidimensional case and by analyticity. Note that the existence of y (and thus the domain of definition) is a hypothesis of the definition.

Consider $x \in I$ and γ a smooth curve³ from x_0 to x with values in I and consider $z(t) = y(\gamma(t))$ for $t \in [0, 1]$. It can be seen that $z'(t) = J_y(\gamma(t))\gamma'(t) = p(y(\gamma(t)))\gamma'(t) = p(z(t))\gamma'(t)$, $z(0) = y(x_0) = y_0$ and $z(1) = y(x)$. The initial value problem $z(0) = y_0$ and $z'(t) = p(z(t))\gamma'(t)$ satisfies the hypothesis of the Cauchy-Lipschitz theorem and as such admits a unique solution. Since this IVP is independent of y , the value of $z(1)$ is unique and must be equal to $y(x)$, for any solution y and any x . This implies that y must be unique.

Alternatively, use Proposition 31 to conclude that any solution must be analytic. Assume that there are two solutions y and z . Then all partial derivatives at any order at the initial point x_0 are equal because they only depend on y_0 . Thus y and z have the same partial derivatives at all order and must be equal on a small open ball around y_0 . A classical argument of finite covering with open balls then extends this argument to any point of the interior of domain of definition that is connected to y_0 . Since the domain of definition is assumed to be open and connected, this concludes to the equality of y and z .

Remark 16 (Regularity) In the euclidean space \mathbb{R}^n , C^k smoothness is equivalent to the smoothness of the order k partial derivatives. Consequently, the equation $J_y = p(y)$ on the open set I immediately proves that y is C^∞ . Proposition 31 shows that y is in fact real analytic.

Remark 17 (Domain of definition) Definition 14 requires the domain of definition of f to be connected, otherwise it would not make sense. Indeed, we can only define the value of f at point u if there exists a path from x_0 to u in the domain of f . It could seem, at first sight, that the domain being “only” connected may be too weak to work with. This is not the case, because in the euclidean space \mathbb{R}^d , open connected subsets are always smoothly arc connected, that is any two points can be connected using a smooth C^1 (and even C^∞) arc. Proposition 54 extends this idea to generable arcs, with a very useful corollary.

Remark 18 (Multidimensional output) Remark 5 also applies to this definition: $f : \subseteq \mathbb{R}^d \rightarrow \mathbb{R}^n$ is generable if and only if each of its component is generable (i.e. f_i is generable for all i).

Remark 19 (Definition consistency) It should be clear that Definition 14 and Definition 2 are consistent. More precisely, in the case of unidimensional function ($d = 1$) with domain of definition $I = \mathbb{R}$, both definitions are exactly the same since $J_y = y'$ and $M_{n,1}(\mathbb{R}) = \mathbb{R}^n$.

The following example focuses on the second issue mentioned at the beginning of the section, namely the domain of definition.

Example 20 (Inverse and logarithm functions) We illustrate that the choice of the domain of definition makes important differences in the nature of the function.

- Let $0 < \varepsilon < 1$ and define $f_\varepsilon : x \in]\varepsilon, \infty[\mapsto \frac{1}{x}$. It can be seen that $f'_\varepsilon(x) = -f_\varepsilon(x)^2$ and $f_\varepsilon(1) = 1$. Furthermore, $|f_\varepsilon(x)| \leq \frac{1}{\varepsilon}$ thus $f_\varepsilon \in \text{GVAL}[\alpha \mapsto \frac{1}{\varepsilon}]$. So in particular, $f_\varepsilon \in \text{GVAL}[\text{poly}]$ for any $\varepsilon > 0$. Something interesting arises when $\varepsilon \rightarrow 0$: define $f_0(x) = x \in (0, \infty) \mapsto \frac{1}{x}$.

³see Remark 17

Then f_0 is still generable and $|f_0(x)| \leq \frac{1}{|x|}$. Thus $f_0 \in \text{GVAL}[\alpha \mapsto \frac{1}{\alpha}]$ but $f_0 \notin \text{GVAL}[\text{poly}]$. Note that strictly speaking, $f_0 \in \text{GVAL}[\text{sp}]$ where $\text{sp}(\alpha) = \frac{1}{\alpha}$ and $\text{sp}(0) = 0$ because the bound function needs to be defined over $\mathbb{R}_{\geq 0}$.

- A similar phenomenon occurs with the logarithm: define $g_\varepsilon : x \in (\varepsilon, \infty) \mapsto \ln(x)$. Then $g'_\varepsilon(x) = f_\varepsilon(x)$ and $g_\varepsilon(1) = 0$. Furthermore, $|g_\varepsilon(x)| \leq \max(|x|, |\ln \varepsilon|)$. Thus $g_\varepsilon \in \text{GVAL}[\alpha \mapsto \max(\alpha, |\ln \varepsilon|, \frac{1}{\varepsilon})]$, and in particular $g_\varepsilon \in \text{GVAL}[\text{poly}]$ for any $\varepsilon > 0$. Similarly, $g_0 : x \in]0, \infty[\mapsto \ln(x)$ is generable but does not belong to $\text{GVAL}[\text{poly}]$.

Example 21 (Classical non-generable functions) While many of the usual real functions are known to be generated by a GPAC, a notable exception is Euler's Gamma function $\Gamma(x) = \int_0^\infty t^{x-1} e^{-t} dt$ function or Riemann's Zeta function $\zeta(x) = \sum_{k=1}^\infty \frac{1}{k^x}$ [Sha41], [PER89]. Furthermore, Riemann's Zeta function (over, for example, $[2, \infty)$) is an example of real-analytic, polynomially-bounded that is not in $\text{GVAL}[\text{poly}]$.

Example 22 (Generable functions not in $\text{GVAL}[\text{poly}]$) We have seen that Riemann's Zeta function ζ is an example of a function not in $\text{GVAL}[\text{poly}]$ due to the fact that it is not generable. An example of a generable function not belonging to $\text{GVAL}[\text{poly}]$ is the exponential e^x because, while it is generable, its derivative is not bounded by another polynomial. Note that it is quite possible to have bounded generable functions which do not belong to $\text{GVAL}[\text{poly}]$. An example is the function given by $f(x) = \sin(e^x)$ which is generable and bounded, but its derivative $f'(x) = e^x \cos(e^x)$ is not bounded by any polynomial.

The previous examples show that $\text{GVAL}_{\mathbb{K}}[\text{sp}]$ can be used to define a proper hierarchy of generable functions. Adapting the examples given in Example 22 one can show for instance that

$$\text{GVAL}[\text{poly}] \subsetneq \text{GVAL}[e^x] \subsetneq \text{GVAL}[e^{e^x}] \subsetneq \dots$$

In particular these examples show the following result.

Theorem 23 (Existence of noncollapsing classes) $\text{GVAL}[\text{poly}] \subsetneq \text{GVAL}$.

3 Stability properties

In this section, the major results will be stability of multidimensional generable functions under arithmetical operators, composition and ODE solving. Note that some of the results use properties on \mathbb{K} which can be found in Section 6.1.

Lemma 24 (Arithmetic on generable functions) Let $d, \ell, n, m \in \mathbb{N}$, $\text{sp}, \overline{\text{sp}} : \mathbb{R} \rightarrow \mathbb{R}_{\geq 0}$, $f : \subseteq \mathbb{R}^d \rightarrow \mathbb{R}^n \in \text{GVAL}[\text{sp}]$ and $g : \subseteq \mathbb{R}^\ell \rightarrow \mathbb{R}^m \in \text{GVAL}[\overline{\text{sp}}]$. Then:

- $f + g, f - g \in \text{GVAL}[\text{sp} + \overline{\text{sp}}]$ over $\text{dom } f \cap \text{dom } g$ if $d = \ell$ and $n = m$
- $fg \in \text{GVAL}[\max(\text{sp}, \overline{\text{sp}}, \text{sp} \overline{\text{sp}})]$ if $d = \ell$ and $n = m$
- $f \circ g \in \text{GVAL}[\max(\overline{\text{sp}}, \text{sp} \circ \overline{\text{sp}})]$ if $m = d$ and $g(\text{dom } g) \subseteq \text{dom } f$

Proof. We focus on the case of the composition, the other cases are very similar.

Apply Definition 14 to f and g to respectively get $l, \bar{l} \in \mathbb{N}$, $p \in M_{l,d}(\mathbb{K})[\mathbb{R}^l]$, $\bar{p} \in M_{\bar{l},\ell}(\mathbb{K})[\mathbb{R}^{\bar{l}}]$, $x_0 \in \text{dom } f \cap \mathbb{K}^d$, $\bar{x}_0 \in \text{dom } g \cap \mathbb{K}^\ell$, $y_0 \in \mathbb{K}^l$, $\bar{y}_0 \in \mathbb{K}^{\bar{l}}$, $y : \text{dom } f \rightarrow \mathbb{R}^l$ and $\bar{y} : \text{dom } g \rightarrow \mathbb{R}^{\bar{l}}$. Define $h = y \circ g$, then $J_h = J_y(g)J_g = p(h)\bar{p}_{1..m}(\bar{y})$ and $h(\bar{x}_0) = y(\bar{y}_0) \in \mathbb{K}^l$ by Corollary 55. In other words (\bar{y}, h) satisfy:

$$\begin{cases} \bar{y}(\bar{x}_0) = y_0 \in \mathbb{K}^l \\ h(\bar{x}_0) = y(\bar{y}_0) \in \mathbb{K}^l \end{cases} \quad \begin{cases} \bar{y}' = \bar{p}(\bar{y}) \\ h' = p(h)\bar{p}_{1..m}(\bar{y}) \end{cases}$$

This shows that $f \circ g = z_{1..m} \in \text{GVAL}$. Furthermore,

$$\begin{aligned} \|(\bar{y}(x), h(x))\| &\leq \max(\|\bar{y}(x)\|, \|y(g(x))\|) \\ &\leq \max(\bar{\text{sp}}(\|x\|), \text{sp}(\|g(x)\|)) \\ &\leq \max(\bar{\text{sp}}(\|x\|), \text{sp}(\bar{\text{sp}}(\|x\|))). \end{aligned}$$

■

Our main result is that the solution to an ODE whose right hand-side is generable, and possibly depends on an external and C^1 control, may be rewritten as a GPAC. A corollary of this result is that the solution to a generable ODE is generable.

Proposition 25 (Generable ODE rewriting) *Let $d, n \in \mathbb{N}$, $I \subseteq \mathbb{R}^n$, $X \subseteq \mathbb{R}^d$, $\text{sp} : \mathbb{R}_{\geq 0} \rightarrow \mathbb{R}_{\geq 0}$ and $(f : I \times X \rightarrow \mathbb{R}^n) \in \text{GVAL}_{\mathbb{K}}[\text{sp}]$. Define $\bar{\text{sp}} = \max(\text{id}, \text{sp})$. Then there exists $m \in \mathbb{N}$, $(g : I \times X \rightarrow \mathbb{R}^m) \in \text{GVAL}_{\mathbb{K}}[\bar{\text{sp}}]$ and $p \in \mathbb{K}^m[\mathbb{R}^m \times \mathbb{R}^d]$ such that for any interval J , $t_0 \in \mathbb{K} \cap J$, $y_0 \in \mathbb{K}^n \cap J$, $y \in C^1(J, I)$ and $x \in C^1(J, X)$, if y satisfies:*

$$\begin{cases} y(t_0) = y_0 \\ y'(t) = f(y(t), x(t)) \end{cases} \quad \forall t \in J$$

then there exists $z \in C^1(J, \mathbb{R}^m)$ such that:

$$\begin{cases} z(t_0) = g(y_0, x(t_0)) \\ z'(t) = p(z(t), x'(t)) \end{cases} \quad \begin{cases} y(t) = z_{1..d}(t) \\ \|z(t)\| \leq \bar{\text{sp}}(\max(\|y(t)\|, \|x(t)\|)) \end{cases} \quad \forall t \in J$$

Proof. Apply Definition 14 to f get $m \in \mathbb{N}$, $p \in M_{m,n+d}(\mathbb{K})[\mathbb{R}^m]$, $f_0 \in \text{dom } f \cap \mathbb{K}^d$, $w_0 \in \mathbb{K}^m$ and $w : \text{dom } f \rightarrow \mathbb{R}^m$ such that $w(f_0) = w_0$, $J_{w(v)} = p(w(v))$, $\|w(v)\| \leq \text{sp}(\|v\|)$ and $w_{1..n}(v) = f(v)$ for all $v \in \text{dom } f$. Define $u(t) = w(y(t), x(t))$, then:

$$\begin{aligned} u'(t) &= J_w(y(t), x(t))(y'(t), x'(t)) \\ &= p(w(y(t), x(t)))(f(y(t), x(t)), x'(t)) \\ &= p(u(t))(u_{1..n}(t), x'(t)) \\ &= q(u(t), x'(t)) \end{aligned}$$

where $q \in \mathbb{K}^m[\mathbb{R}^{m+d}]$ and $u(t_0) = w(y(t_0), x(t_0))$. Note that w itself is a generable function and more precisely $w \in \text{GVAL}_{\mathbb{K}}[\text{poly}]$ by definition. Finally, note that $y'(t) = u_{1..d}(t)$ so that we get for all $t \in J$:

$$\begin{cases} y(t_0) = y_0 \\ y'(t) = u_{1..d}(t) \end{cases} \quad \begin{cases} u(t_0) = w(y_0, x(t_0)) \\ u'(t) = q(u(t), x'(t)) \end{cases}$$

Define $z(t) = (y(t), u(t))$, then $z(t_0) = (y_0, w(y_0, x(t_0))) = g(y_0, x(t_0))$ where $y_0 \in \mathbb{K}^n$ and $w \in \text{GVAL}_{\mathbb{K}}[\mathbf{sp}]$ so $g \in \text{GVAL}_{\mathbb{K}}[\overline{\mathbf{sp}}]$. And clearly $z'(t) = r(z(t), x'(t))$ where $r \in \mathbb{K}^{n+m}[\mathbb{R}^{n+m}]$. Finally, $\|z(t)\| = \max(\|y(t)\|, \|w(y(t), x(t))\|) \leq \max(\|y(t)\|, \mathbf{sp}(\max(\|y(t)\|, \|x(t)\|))) \leq \overline{\mathbf{sp}}(\max(\|y(t)\|, \|x(t)\|))$. ■

A simplified version of this lemma shows that generable functions are closed under ODE solving.

Corollary 26 (Generable functions are closed under ODE) *Let $d \in \mathbb{N}$, $J \subseteq \mathbb{R}$ an interval, $\mathbf{sp}, \overline{\mathbf{sp}} : \mathbb{R}_{\geq 0} \rightarrow \mathbb{R}_{\geq 0}$, $f : \subseteq \mathbb{R}^d \rightarrow \mathbb{R}^d$ in $\text{GVAL}[\mathbf{sp}]$, $t_0 \in \mathbb{K} \cap J$ and $y_0 \in \mathbb{K}^d \cap \text{dom } f$. Assume there exists $y : J \rightarrow \text{dom } f$ satisfying for all $t \in J$:*

$$\begin{cases} y(t_0) = y_0 \\ y'(t) = f(y(t)) \end{cases} \quad \|y(t)\| \leq \overline{\mathbf{sp}}(t)$$

Then $y \in \text{GVAL}[\max(\overline{\mathbf{sp}}, \mathbf{sp} \circ \overline{\mathbf{sp}})]$ and is unique.

Remark 27 (Polynomially bounded generable functions) *In light of the stability properties above, the class of polynomially bounded generable functions,*

$$\text{GVAL}[\text{poly}] = \bigcup_{k=1}^{\infty} \text{GVAL}[\alpha \mapsto k\alpha^k]$$

is particularly interesting because it is stable by operations: addition, multiplication, composition and ODE solving (provided the solution is polynomially bounded). Notice that $\text{GVAL}[\text{poly}]$ is not simply the intersection of GVAL with the set of functions bounded by a polynomial, as shown in Example 22.

Our last result is simple but very useful. Generable functions are continuous and continuously differentiable, so locally Lipschitz continuous. We can give a precise expression for the modulus of continuity in the case where the domain of definition is simple enough.

Proposition 28 (Modulus of continuity) *Let $\mathbf{sp} : \mathbb{R}_{\geq 0} \rightarrow \mathbb{R}_{\geq 0}$, $f \in \text{GVAL}[\mathbf{sp}]$. There exists $q \in \mathbb{K}[\mathbb{R}]$ such that for any $x_1, x_2 \in \text{dom } f$, if $[x_1, x_2] \subseteq \text{dom } f$ then $\|f(x_1) - f(x_2)\| \leq \|x_1 - x_2\| q(\mathbf{sp}(\max(\|x_1\|, \|x_2\|)))$. In particular, if $\text{dom } f$ is convex then f has a polynomial modulus of continuity.*

Proof. Apply Definition 14 to get d, ℓ, n, p, x_0, y_0 and y . Let $k = \deg(p)$. Recall that for a matrix, the subordinate norm is given by $\|M\| = \max_i \sum_j |M_{ij}|$. Then:

$$\begin{aligned} \|f(x_1) - f(x_2)\| &= \left\| \int_{x_1}^{x_2} J_{y_{1..l}}(x) dx \right\| = \left\| \int_0^1 J_{y_{1..l}}((1-\alpha)x_1 + \alpha x_2)(x_2 - x_1) d\alpha \right\| \\ &\leq \int_0^1 \|J_{y_{1..l}}((1-\alpha)x_1 + \alpha x_2)\| \cdot \|x_2 - x_1\| d\alpha \\ &\leq \|x_2 - x_1\| \int_0^1 \max_{i \in [1, \ell]} \sum_{j=1}^d |p_{ij}(y((1-\alpha)x_1 + \alpha x_2))| d\alpha \\ &\leq \|x_2 - x_1\| \int_0^1 \max_{i \in [1, \ell]} \sum_{j=1}^d \Sigma p \max(1, \|y((1-\alpha)x_1 + \alpha x_2)\|)^k d\alpha \end{aligned}$$

$$\begin{aligned}
&\leq \|x_2 - x_1\| \int_0^1 \max_{i \in [1, \ell]} d\Sigma p \max(1, \mathbf{sp}(\|(1 - \alpha)x_1 + \alpha x_2\|))^k d\alpha \\
&\leq \|x_2 - x_1\| \int_0^1 d\Sigma p \max(1, \mathbf{sp}(\max(\|x_1\|, \|x_2\|)))^k d\alpha \\
&\leq \|x_2 - x_1\| d\Sigma p \max(1, \mathbf{sp}(\max(\|x_1\|, \|x_2\|)))^k
\end{aligned}$$

■

4 Analyticity of generable functions

It is a well-known result that the solution of a PIVP $y' = p(y)$ (and more generally, of an analytic differential equation $y' = f(y)$ where f is analytic) is real analytic on its domain of definition. In the previous section we defined a generalized notion of generable function satisfying $J_y = p(y)$ which analyticity is less immediate. In this section we go through the proof in detail, which of course subsumes the result for PIVP.

We recall a well-known characterization of analytic functions. It is indeed much easier to show that a function is infinitely differentiable and of controlled growth, rather than showing the convergence of the Taylor series.

Proposition 29 (Characterization of analytic functions) *Let $f \in C^\infty(U)$ for some open subset U of \mathbb{R}^m . Then f is analytic on U if and only if, for each $u \in U$, there are an open ball V , with $u \in V \subseteq U$, and constants $C > 0$ and $R > 0$ such that the derivatives of f satisfy*

$$|\partial_\alpha f(x)| \leq C \frac{\alpha!}{R^{|\alpha|}} \quad x \in V, \alpha \in \mathbb{N}^m$$

Proof. See proposition 2.2.10 of [KP02]. ■

In order to use this result, we show that the derivatives of generable functions at a point x do not grow faster than the described bound. We use a generalization of Faà di Bruno formula for the derivatives of a composition.

Theorem 30 (Generalised Faà di Bruno's formula) *Let $f : X \subseteq \mathbb{R}^d \rightarrow Y \subseteq \mathbb{R}^n$ and $g : Y \rightarrow \mathbb{R}$ where X, Y are open sets and f, g are sufficiently smooth functions⁴. Let $\alpha \in \mathbb{N}^d$ and $x \in X$, then*

$$\partial_\alpha (g \circ f)(x) = \alpha! \sum_{(s, \beta, \lambda) \in \mathcal{D}_\alpha} \partial_\lambda g(f(x)) \prod_{k=1}^s \frac{1}{\lambda_k!} \left(\frac{1}{\beta_k!} \partial_{\beta_k} f(x) \right)^{\lambda_k}$$

where ∂_λ means $\partial_{\sum_{u=1}^s \lambda_u}$ and where \mathcal{D}_α is the list of decompositions of α . A multi-index $\alpha \in \mathbb{N}^d$ is decomposed into $s \in \mathbb{N}$ parts $\beta_1, \dots, \beta_s \in \mathbb{N}^d$ with multiplicities $\lambda_1, \dots, \lambda_s \in \mathbb{N}^n$ respectively if $|\lambda_i| > 0$ for all i , all the β_i are distincts from each other and from 0, and $\alpha = |\lambda_1| \beta_1 + \dots + |\lambda_s| \beta_s$. Note that β and λ are multi-indices of multi-indices: $\beta \in (\mathbb{N}^d)^s$ and $\lambda \in (\mathbb{N}^d)^s$.

⁴More precisely, for the formula to hold for α , all the derivatives which appear in the right-hand side must exist and be continuous

Proof. See [Ma09] or [EM03]. ■

We have seen that one-dimensional GPAC generable functions are analytic. We now extend this result to the multidimensional case.

Proposition 31 (Generable implies analytic) *If $f \in \overline{\text{GVAL}}$ then f is real-analytic on $\text{dom } f$.*

Proof. Let $\text{sp} : \mathbb{R} \rightarrow \mathbb{R}_{\geq 0}$, $p \in M_{n,d}[\mathbb{R}^n]$ and $y : \mathbb{R}^n \rightarrow \mathbb{R}^n$ from Definition 14. It is sufficient to prove that y is analytic on $D = \text{dom } f$ to get the result. Let $i \in \llbracket 1, n \rrbracket$, and $j \in \llbracket 1, d \rrbracket$, since $J_y = p(y)$ then $\partial_j y_i(x) = p_{ij}(y(x))$ and p_{ij} is a polynomial vector so clearly C^∞ . By Remark 16, y is also C^∞ so we can apply Theorem 30 for any $x \in D$, $\alpha \in \mathbb{N}^d$ and get

$$\partial_\alpha(\partial_j y_i)(x) = \partial_\alpha(p_{ij} \circ y)(x) = \alpha! \sum_{(s,\beta,\lambda) \in \mathcal{D}_\alpha} \partial_\lambda p_{ij}(y(x)) \prod_{k=1}^s \frac{1}{\lambda_k!} \left(\frac{1}{\beta_k!} \partial_{\beta_k} y(x) \right)^{\lambda_k}$$

Define $B_\alpha(x) = \frac{1}{\alpha!} \|\partial_\alpha y(x)\|$, and denote by $\alpha + j$ the multi-index λ such that $\lambda_j = \alpha_j + 1$ and $\lambda_k = \alpha_k$ for $k \neq j$. Define $C(y(x)) = \max_{i,j,\lambda} (|\partial_\lambda p_{ij}(y(x))|)$ and note that it is well-defined because $\partial_\lambda p_{ij}$ is zero whenever $|\lambda| > \text{deg}(p_{ij})$. Define $\mathcal{D}'_\alpha = \{(s, \beta, \lambda) \in \mathcal{D}_\alpha \mid |\lambda| \leq \text{deg}(p)\}$. The equations becomes:

$$\begin{aligned} |\partial_\alpha(\partial_j y_i)(x)| &\leq \alpha! \sum_{(s,\beta,\lambda) \in \mathcal{D}_\alpha} |\partial_\lambda p_{ij}(y(x))| \prod_{k=1}^s \frac{1}{\lambda_k!} \left| \frac{1}{\beta_k!} \partial_{\beta_k} y(x) \right|^{\lambda_k} \\ &\leq \alpha! C(y(x)) \sum_{(s,\beta,\lambda) \in \mathcal{D}'_\alpha} \prod_{k=1}^s \frac{1}{\lambda_k!} B_{\beta_k}(x)^{|\lambda_k|}. \end{aligned}$$

Note that the right-hand side of the expression does not depend on i . We are going to show by induction that $B_\alpha(x) \leq \left(\frac{C(y(x))}{R} \right)^{|\alpha|}$ for some choice of R . The initialization for $|\alpha| = 1$ is trivial because $\alpha! = 1$ and $B_\alpha(x) = \|\partial_\alpha y(x)\| \leq C(y(x))$ so we only need $R \leq 1$. The induction step is as follows:

$$\begin{aligned} B_{\alpha+j}(x) &\leq C(y(x)) \sum_{(s,\beta,\lambda) \in \mathcal{D}'_\alpha} \prod_{k=1}^s \frac{1}{\lambda_k!} B_{\beta_k}(x)^{|\lambda_k|} \\ &\leq C(y(x)) \sum_{(s,\beta,\lambda) \in \mathcal{D}'_\alpha} \prod_{k=1}^s \frac{1}{\lambda_k!} \left(\frac{C(y(x))}{R} \right)^{|\beta_k| |\lambda_k|} \\ &\leq C(y(x)) \sum_{(s,\beta,\lambda) \in \mathcal{D}'_\alpha} \frac{1}{\lambda!} \left(\frac{C(y(x))}{R} \right)^{\sum_{u=1}^s |\beta_u| |\lambda_u|} \\ &\leq C(y(x)) \left(\frac{C(y(x))}{R} \right)^{|\alpha|} \sum_{(s,\beta,\lambda) \in \mathcal{D}'_\alpha} \frac{1}{\lambda!} \\ &\leq C(y(x)) \left(\frac{C(y(x))}{R} \right)^{|\alpha|} \#\mathcal{D}'_\alpha. \end{aligned}$$

Evaluating the exact cardinal of \mathcal{D}'_α is complicated but we only need a good enough bound to get on with it. First notice that for any $(s, \beta, \lambda) \in \mathcal{D}'_\alpha$, we

have $|\lambda| \leq \deg(p)$ by definition, and since each $|\lambda_i| > 0$, necessarily $s \leq \deg(p)$. This means that there is a finite number, denote it by A , of (s, λ) in \mathcal{D}'_α . For a given λ , we must have $\alpha = \sum_{i=1}^s |\lambda_i| \beta_i$ which implies that $|\beta_{ij}| \leq |\alpha|$ and so there at most $(1 + |\alpha|)^{ns}$ choices for β , and since $s \leq \deg(p)$, $\#\mathcal{D}'_\alpha \leq A(1 + |\alpha|)^b$ where b and A are constants. Choose $R \leq 1$ such that $R^{|\alpha|} \geq A(1 + |\alpha|)^b$ for all α to get the claimed bound on $B_\alpha(x)$.

To conclude with Proposition 29, consider $x \in D$. Let V be an open ball of D containing x . Let $M = \sup_{u \in V} C(y(x))$, it is finite because C is bounded by a polynomial, $\|y(x)\| \leq \mathbf{sp}(x)$ and V is an open ball (thus included in a compact set). Finally we get:

$$\|\partial_\alpha y(x)\| \leq \alpha! \left(\frac{M}{R}\right)^{|\alpha|}$$

■

5 Generable zoo

In this section, we introduce a number of generable functions. Since a GPAC (PIVP) only generates analytic functions, it cannot generate discontinuous functions like the sign. However these functions can be arbitrarily approximated by GPACs, as we show in this section, where we present a “zoo” of such approximating functions. This zoo illustrates the wide range of generable functions. Some of the functions selected in this “zoo” were chosen to approximate non-continuous functions traditionally used in computer programs like the absolute value or the sign function. Other functions were selected due to their usefulness for potential applications, like simulating Turing machines with a GPAC, using a bounded amount of resources, which we intend to explore in an incoming paper.

We note that the approximation of a discontinuous functions by a GPAC generable function is uniform, since we provide the GPAC with a parameter which sets the maximum allowed error of the approximation. The use of different values of the parameter by the same GPAC allows to dynamically change the quality of the approximation, without making any other change on the GPAC. The table below gives a list of the functions and their purpose.

We use the term “dead zone” to refer to interval(s) where the generable function does not compute the expected function (but still has controlled behavior). We use the term “high” to mean that the function is close to x (an input) within $e^{-\mu}$ where μ is another input. Conversely, the use the term “low” to mean that it is close to 0 within $e^{-\mu}$. And “X” means something in between. Finally “integral” means that function is of the form ϕx and the integral of ϕ (on some interval) is between 1 and a constant.

We conclude this section by giving a large class of functions that can be uniformly approximated by (polynomially bounded) generable functions, except on a small number of dead zones (typically at discontinuity points) that can be made arbitrary small, see Section 5.4.

Generable Zoo

Name	Notation	Comment
Sign	$\text{sg}(x, \mu, \lambda)$	Compute the sign of x with error $e^{-\mu}$ and dead zone in $[-\lambda^{-1}, \lambda^{-1}]$. See 34

Generable Zoo

Name	Notation	Comment
Floor	$\text{ip}_1(x, \mu, \lambda)$	Compute $\text{int}_1(x)$ with error $e^{-\mu}$ and dead zone in $[-\lambda^{-1}, \lambda^{-1}]$. See 36
Abs	$\text{abs}(x, \mu, \lambda)$	Compute $ x $ with error with error $e^{-\mu}$ and dead zone in $[-\lambda^{-1}, \lambda^{-1}]$. See 40
Max	$\text{mx}(x, y, \mu, \lambda)$	Compute $\max(x, y)$ and $\ x\ $ with error $e^{-\mu}$ and dead zone for $x - y \in [-\lambda^{-1}, \lambda^{-1}]$. See 42
Norm	$\text{norm}_\delta(x, \mu, \lambda)$	Compute $\ x\ $ with error δ . See 44
Round	$\text{rnd}(x, \mu, \lambda)$	Compute $[x]$ with error $e^{-\mu}$ and dead zones in $[n - \frac{1}{2} + \lambda^{-1}, n + \frac{1}{2} - \lambda^{-1}]$ for all $n \in \mathbb{Z}$. See 38
Low-X-High	$\text{lxh}_{[a,b]}(t, \mu, x)$	Compute 0 when $t \in] - \infty, a]$ and x when $t \in [b, \infty[$ with error $e^{-\mu}$ and a dead zone in $[a, b]$. See 46
High-X-Low	$\text{hxl}_{[a,b]}(t, \mu, x)$	Compute x when $t \in] - \infty, a]$ and 0 when $t \in [b, \infty[$ with error $e^{-\mu}$ and a dead zone in $[a, b]$. See 46

5.1 Sign and rounding

We begin with a small result on the hyperbolic tangent function, which will be used to build several generable functions of interest.

Lemma 32 (Bounds on tanh) $1 - \text{sgn}(t) \tanh(t) \leq e^{-|t|}$ for all $t \in \mathbb{R}$.

Proof. The case of $t = 0$ is trivial. Assume that $t \geq 0$ and observe that $1 - \tanh(t) = 1 - \frac{1 - e^{-2t}}{1 + e^{-2t}} = \frac{2e^{-2t}}{1 + e^{-2t}} = e^{-t} \frac{2e^{-t}}{1 + e^{-2t}}$. Define $f(t) = \frac{2e^{-t}}{1 + e^{-2t}}$ and check that $f'(t) = \frac{2e^{-t}(e^{-2t} - 1)}{(1 + e^{-2t})^2} \leq 0$ for $t \geq 0$. Thus f is a non-increasing function and $f(0) = 1$ which concludes.

If $t < 0$ then note that $1 - \text{sgn}(t) \tanh(t) = 1 - \text{sgn}(-t) \tanh(-t)$ so we can apply the result to $-t \geq 0$ to conclude. ■

The simplest generable function of interest uses the hyperbolic tangent to approximate the sign function. On top of the sign function, we can build an approximation of the floor function. See Figure 7 for a graphical representation.

Definition 33 (Sign function) For any $x, \mu, \lambda \in \mathbb{R}$ define

$$\text{sg}(x, \mu, \lambda) = \tanh(x\mu\lambda)$$

Lemma 34 (Sign) $\text{sg} \in \text{GVAL}[\text{poly}]$ and for any $x \in \mathbb{R}$ and $\lambda, \mu \geq 0$,

$$|\text{sgn}(x) - \text{sg}(x, \mu, \lambda)| \leq e^{-|x|\lambda\mu} \leq 1$$

In particular, sg is non-decreasing in x and if $|x| \geq \lambda^{-1}$ then

$$|\text{sgn}(x) - \text{sg}(x, \mu, \lambda)| \leq e^{-\mu}$$

Proof. Note that $\text{sg} = \tanh \circ f$ where $f(x, \mu, \lambda) = x\mu\lambda$. We saw in Example 7 that $\tanh \in \text{GVAL}[t \mapsto 1]$. By Lemma 24, $f \in \text{GVAL}[\alpha \mapsto \max(1, \alpha^3)]$. Thus $\text{sg} \in \text{GVAL}[\alpha \mapsto \max(1, \alpha^3)]$.

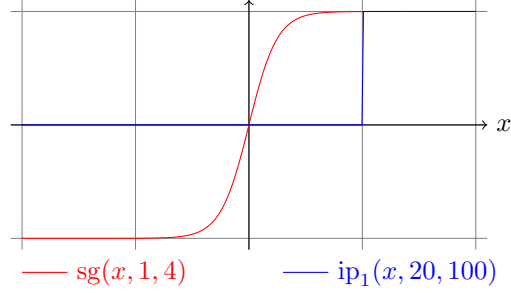

Figure 7: Graph of sg and ip_1 .

Use Lemma 32 and the fact that \tanh is an odd function to get the first bound. The second bound derives easily from the first. Finally, sg is a non-decreasing function because \tanh is an increasing function. ■

Definition 35 (Floor function) For any $x, \mu, \lambda \in \mathbb{R}$ define

$$\text{ip}_1(x, \mu, \lambda) = \frac{1 + \text{sg}(x - 1, \mu, \lambda)}{2}$$

Lemma 36 (Floor) $\text{ip}_1 \in \text{GVAL}[\text{poly}]$ and for any $x \in \mathbb{R}$ and $\mu, \lambda \geq 0$,

$$|\text{int}_1(x) - \text{ip}_1(x, \mu, \lambda)| \leq \frac{e^{-|x-1|\lambda\mu}}{2} \leq \frac{1}{2}$$

where $\text{int}_1(x) = 0$ if $x < 1$ and 1 if $x \geq 1$. In particular ip_1 is non-decreasing in x and if $|1 - x| \geq \lambda^{-1}$ then

$$|\text{int}_1(x) - \text{ip}_1(x, \mu, \lambda)| < e^{-\mu}$$

We will now see how to build a very precise approximation of the rounding function. Of course rounding is not a continuous operation so we need a small deadzone around the discontinuity points.

Definition 37 (Round function) For any $x \in \mathbb{R}$, $\lambda \geq 2$ and $\mu \geq 0$, define

$$\begin{aligned} \text{rnd}(x, \mu, \lambda) &= x - \frac{1}{\pi} \arctan(\text{cltan}(\pi x, \mu, \lambda)) \\ \text{cltan}(\theta, \mu, \lambda) &= \frac{\sin(\theta)}{\sqrt{\text{nz}(\cos^2 \theta, \mu + 16\lambda^3, 4\lambda^2)}} \text{sg}(\cos \theta, \mu + 3\lambda, 2\lambda) \\ \text{nz}(x, \mu, \lambda) &= x + \frac{2}{\lambda} \text{ip}_1\left(1 - x + \frac{3}{4\lambda}, \mu + 1, 4\lambda\right) \end{aligned}$$

Lemma 38 (Round) For any $n \in \mathbb{Z}$, $\lambda \geq 2$, $\mu \geq 0$, we have $|\text{rnd}(x, \mu, \lambda) - n| \leq \frac{1}{2}$ for all $x \in [n - \frac{1}{2}, n + \frac{1}{2}]$ and $|\text{rnd}(x, \mu, \lambda) - n| \leq e^{-\mu}$ for all $x \in [n - \frac{1}{2} + \frac{1}{\lambda}, n + \frac{1}{2} - \frac{1}{\lambda}]$. Furthermore $\text{rnd} \in \text{GVAL}[\text{poly}]$.

Proof. Let's start with the intuition first: consider $f(x) = x - \frac{1}{\pi} \arctan(\tan(\pi x))$. It is an exact rounding function: if $x = n + \delta$ with $n \in \mathbb{N}$ and $\delta \in]\frac{-1}{2}, \frac{1}{2}[$ then $\tan(\pi x) = \tan(\pi \delta)$ and since $\delta \pi \in]\frac{-\pi}{2}, \frac{\pi}{2}[$, $f(x) = x - \delta = n$. The problem is that it is undefined on all points of the form $n + \frac{1}{2}$ because of the tangent function.

The idea is to replace $\tan(\pi x)$ by some “clamped” tangent cltan which will be like $\tan(\pi x)$ around integer points and stay bounded when close to $x = n + \frac{1}{2}$ instead of exploding. To do so, we use the fact that $\tan \theta = \frac{\sin \theta}{\cos \theta}$ but this formula is problematic because we cannot prevent the cosine from being zero, without loosing the sign of the expression (the cosine could never change sign). Thus the idea is to remove the sign from the cosine, and restore it, so that $\tan \theta = \text{sgn}(\cos \theta) \frac{\sin \theta}{|\cos \theta|}$. And now we can replace $|\cos(\theta)|$ by $\sqrt{\text{nz}(\cos^2 \theta)}$, where $\text{nz}(x)$ is mostly x except near 0 where is lower-bounded by some small constant (so it is never zero). The sign of cosine can be computed using our approximate sign function sg .

Formally, we begin with nz and show that:

- $\text{nz} \in \text{GVAL}[\text{poly}]$
- nz is an increasing function of x
- For $x \geq \frac{1}{\lambda}$, $|\text{nz}(x, \mu, \lambda) - x| \leq e^{-\mu}$
- For $x \geq 0$, $\text{nz}(x, \mu, \lambda) \geq \frac{1}{2\lambda}$

The first point is a consequence of $\text{ip}_1 \in \text{GVAL}[\text{poly}]$ from Corollary 36. The second point comes from Corollary 36: if $x \geq \frac{1}{\lambda}$, then $1 - x + \frac{3}{4\lambda} \leq 1 - \frac{1}{4\lambda}$, thus $|\text{nz}(x, \mu, \lambda) - x| \leq \frac{2}{\lambda} e^{-\mu-1} \leq e^{-\mu}$ since $\lambda \geq 2$. To show the last point, first apply Corollary 36: if $x \leq \frac{1}{2\lambda}$, then $1 - x + \frac{3}{4\lambda} \geq 1 + \frac{1}{4\lambda}$, thus $|\text{nz}(x, \mu, \lambda) - x - \frac{2}{\lambda}| \leq \frac{2}{\lambda} e^{-\mu-1}$. Thus $\text{nz}(x, \mu, \lambda) \geq \frac{2}{\lambda}(1 - e^{-\mu-1}) + x \geq \frac{1}{\lambda}$ since $1 - e^{-\mu-1} \leq \frac{1}{2}$ and $x \geq 0$. And for $x \geq \frac{1}{2\lambda}$, by Corollary 36 we get that $\text{nz}(x, \mu, \lambda) \geq x \geq \frac{1}{2\lambda}$ which shows the last point.

Then we show that:

- $\text{cltan} \in \text{GVAL}[\text{poly}]$, is π -periodic and is an odd function.
- For $\theta \in [-\frac{\pi}{2} + \frac{1}{\lambda}, \frac{\pi}{2} - \frac{1}{\lambda}]$, $|\text{cltan}(\theta, \mu, \lambda) - \tan(\theta)| \leq e^{-\mu}$

First apply the above results to get that $\text{nz}(\cos^2 \theta, \mu + 16\lambda^3, 4\lambda^2) \geq \frac{1}{8\lambda^2}$. It follows that $\text{cltan}(\theta, \mu, \lambda) \leq \frac{1}{\sqrt{\text{nz}(\cos^2 \theta, \mu + 16\lambda^3, 4\lambda^2)}} \leq \sqrt{8}\lambda$, which is a polynomial in λ . Since $\sin, \cos, \text{sg}, \text{nz} \in \text{GVAL}[\text{poly}]$, it follows that $\text{clan} \in \text{GVAL}[\text{poly}]$. The periodicity comes from the properties of sine and cosine, and the fact that sg is an odd function. It is an odd function for similar reasons. To show the second point, since it is periodic and odd, we can assume that $\theta \in [0, \frac{\pi}{2} - \frac{1}{\lambda}]$. For such a θ , we have that $\frac{\pi}{2} - \theta \geq \frac{1}{\lambda}$, thus $\cos(\theta) \geq \sin(\frac{\pi}{2} - \theta) \geq \frac{1}{2\lambda}$ (use that $\sin(u) \geq \frac{u}{2}$ for $0 \leq u \leq \frac{\pi}{2}$). By Lemma 34 we get that $|\text{sg}(\cos \theta, \mu + 3\lambda, 2\lambda) - 1| \leq e^{-\mu-3\lambda}$. Also $\cos^2 \theta \geq \frac{1}{4\lambda^2}$ thus by the above results we get that $|\text{nz}(\cos^2 \theta, \mu + 16\lambda^3, 4\lambda^2) - \cos^2 \theta| \leq e^{-\mu}$. Using the fact that $|\frac{\sqrt{a}-\sqrt{b}}{\sqrt{a}}| \leq |a-b|$ for any $a > 0$ and $b \in \mathbb{R}$, we get that $\left| \frac{\sqrt{\text{nz}(\cos^2 \theta, \mu, 4\lambda^2)} - |\cos \theta|}{\sqrt{\text{nz}(\cos^2 \theta, \mu + 16\lambda^3, 2\lambda)}} \right| \leq |\text{nz}(\cos^2 \theta, \mu +$

$16\lambda^3, 4\lambda^2) - \cos^2 \theta| \leq \sqrt{8}\lambda e^{-\mu-16\lambda^3}$. Putting everything together, using that $\cos \theta \geq \frac{1}{2\lambda}$ and $\text{nz}(\cos^2 \theta, \mu + 16\lambda^3, 2\lambda) \geq 8\lambda^2$, we get that

$$\begin{aligned}
|\text{cltan}(\theta, \mu, \lambda) - \tan \theta| &= \left| \frac{\sin(\theta) \text{sg}(\cos \theta, \mu + 3\lambda, 2\lambda)}{\sqrt{\text{nz}(\cos^2 \theta, \mu + 16\lambda^3, 4\lambda^2)}} - \frac{\sin \theta}{\cos \theta} \right| \\
&\leq \left| \frac{\sin(\theta)(\text{sg}(\cos \theta, \mu + 3\lambda, 2\lambda) - \text{sgn}(\cos \theta))}{\sqrt{\text{nz}(\cos^2 \theta, \mu + 16\lambda^3, 4\lambda^2)}} \right| \\
&\quad + \left| \frac{\sin(\theta) \text{sgn}(\cos \theta)}{\sqrt{\text{nz}(\cos^2 \theta, \mu + 16\lambda^3, 4\lambda^2)}} - \frac{\sin \theta}{\cos \theta} \right| \\
&\leq \frac{|\text{sg}(\cos \theta, \mu + 3\lambda, 2\lambda) - \text{sgn}(\cos \theta)|}{\sqrt{\text{nz}(\cos^2 \theta, \mu + 16\lambda^3, 4\lambda^2)}} \\
&\quad + \left| \frac{1}{\sqrt{\text{nz}(\cos^2 \theta, \mu + 16\lambda^3, 4\lambda^2)}} - \frac{1}{|\cos \theta|} \right| \\
&\leq \sqrt{8}\lambda e^{-\mu-3\lambda} + \frac{|\sqrt{\text{nz}(\cos^2 \theta, \mu + 16\lambda^3, 4\lambda^2)} - |\cos \theta||}{|\cos \theta| \sqrt{\text{nz}(\cos^2 \theta, \mu + 16\lambda^3, 4\lambda^2)}} \\
&\leq \sqrt{8}\lambda e^{-\mu-3\lambda} + 2\lambda \cdot \sqrt{8}\lambda \cdot \sqrt{8}\lambda e^{-\mu-16\lambda^3} \\
&\leq 3\lambda e^{-\mu-3\lambda} + 16\lambda^3 e^{-\mu-16\lambda^3} \\
&\leq e^{-\mu}
\end{aligned}$$

because $xe^{-x} \leq \frac{1}{2}$ for any $x \geq 0$.

Let $n \in \mathbb{N}$ and $x = n + \delta \in [n - \frac{1}{2}, n + \frac{1}{2}]$. Since cltan is π -periodic, $\text{rnd}(x, \mu, \lambda) = n + \delta - \frac{1}{\pi} \arctan(\text{cltan}(\pi\delta, \mu, \lambda))$. Furthermore $\pi\delta \in [-\frac{\pi}{2}, \frac{\pi}{2}]$ so $\cos(\pi\delta) \geq 0$ and $\text{sgn}(\sin(\pi\delta)) = \text{sgn}(\delta)$. Consequently, $\text{sg}(\cos(\pi\delta), \mu + 3\lambda, 2\lambda) \in [0, 1]$ by definition of sg and $\sqrt{\text{nz}(\cos^2(\pi\delta), \mu + 16\lambda^3, 4\lambda^2)} > \sqrt{\cos^2(\pi\delta)}$ because $\text{ip}_1 > 0$. Consequently, we get that $|\text{cltan}(\pi\delta, \mu, \lambda)| \leq \frac{|\sin(\pi\delta)|}{\cos(\pi\delta)}$ and $\text{sgn}(\text{cltan}(\pi\delta, \mu, \lambda)) = \text{sgn}(\delta)$. Finally, we can write $\frac{1}{\pi} \arctan(\text{cltan}(\pi\delta, \mu, \lambda)) = \alpha$ with $|\alpha| \leq |\frac{1}{\pi} \arctan(\tan(\pi\delta))| \leq |\delta|$ and $\text{sgn}(\alpha) = \text{sgn}(\delta)$ which shows that $|\text{rnd}(x, \mu, \lambda) - n| \leq \delta \leq \frac{1}{2}$.

Finally we can show the result about rnd : since cltan and \tan are in $\text{GVAL}[\text{poly}]$, then $\text{rnd} \in \text{GVAL}[\text{poly}]$. Now consider $x \in [n - \frac{1}{2} + \frac{1}{\lambda}, n + \frac{1}{2} - \frac{1}{\lambda}]$, and let $\theta = \pi x - \pi n$. Then $\theta \in [-\frac{\pi}{2} + \frac{\pi}{\lambda}, \frac{\pi}{2} - \frac{\pi}{\lambda}] \subseteq [-\frac{\pi}{2} + \frac{1}{\lambda}, \frac{\pi}{2} - \frac{1}{\lambda}]$, and since cltan is periodic, then $\text{rnd}(x, \mu, \lambda) = n + \frac{\theta}{\pi} - \frac{1}{\pi} \arctan(\text{cltan}(\theta, \mu, \lambda))$. Finally, using the results about cltan yields: $|\text{rnd}(x, \mu, \lambda) - n| = \frac{1}{\pi} |\theta - \arctan(\text{cltan}(\theta, \mu, \lambda))| = \frac{1}{\pi} |\arctan(\tan(\theta)) - \arctan(\text{cltan}(\theta, \mu, \lambda))| \leq \frac{1}{\pi} |\tan(\theta) - \text{cltan}(\theta, \mu, \lambda)| \leq \frac{e^{-\mu}}{\pi} \leq e^{-\mu}$ since \arctan is a 1-Lipschitz function. ■

5.2 Absolute value, maximum and norm

A very common operation is to compute the absolute value of a number. Of course this operation is not generable because it is not even differentiable. However, a good enough approximation can be built. In particular, this approximation has several key features: it is non-negative and it is an over-approximation. We can then use it to build an approximation of the max function and the infinite norm.

Definition 39 (Absolute value function) For any $x \in \mathbb{R}$ and $\mu, \lambda > 0$ define:

$$\text{abs}(x, \mu, \lambda) = \frac{1}{1 + \lambda\mu} \ln(2 \cosh((1 + \lambda\mu)x))$$

Lemma 40 (Absolute value) For any $x \in \mathbb{R}$ and $\mu, \lambda > 0$ we have

$$|x| \leq \text{abs}(x, \mu, \lambda) \leq |x| + \min\left(\frac{1}{1 + \lambda\mu}, e^{-|x|\lambda\mu}\right).$$

So in particular, if $|x| \geq \lambda^{-1}$ then $|x| \leq \text{abs}(x, \mu, \lambda) \leq |x| + e^{-\mu}$. Furthermore $\text{abs} \in \text{GVAL}[\text{poly}]$ and is an even function.

Proof. Since \cosh is an even function, we immediately get that abs is even. Let $x \geq 0$ and $\mu, \lambda > 0$. Since $2 \cosh(u) \geq e^u$, it trivially follows that $\text{abs}(x, \mu, \lambda) \geq \frac{1}{1 + \lambda\mu}(1 + \lambda\mu)x \geq x$. Also $\ln(2 \cosh(u)) = \ln(e^u(1 + e^{-2u})) = u + \ln(1 + e^{-2u}) \leq u + e^{-2u}$ so it follows that $\text{abs}(x, \mu, \lambda) \leq x + \frac{1}{1 + \lambda\mu}e^{-2(1 + \lambda\mu)x} \leq x + e^{-x\lambda\mu}$. Furthermore, $\frac{\partial \text{abs}}{\partial x}(x, \mu, \lambda) = \tanh((1 + \lambda\mu)x)$ which shows that $x \mapsto \text{abs}(x, \mu, \lambda) - x$ is decreasing and positive over $[0, +\infty[$ and thus has its maximum $\text{abs}(0, \mu, \lambda) = \frac{1}{1 + \lambda\mu}$ attained at 0. Since $(\ln(2 \cosh(u)))' = \tanh(u)$, $\tanh \in \text{GVAL}[\text{poly}]$ and $\ln(2 \cosh(u))$ is bounded by $|u| + 1$, we get that $(u \mapsto \ln(2 \cosh(u))) \in \text{GVAL}[\text{poly}]$ by applying Corollary 26. It follows that $\text{abs} \in \text{GVAL}[\text{poly}]$ using the usual lemmas. ■

Definition 41 (Max/Min function) For any $x, y \in \mathbb{R}$ and $\mu, \lambda > 0$ define:

$$\text{mx}(x, y, \mu, \lambda) = \frac{y + x + \text{abs}(y - x, \mu, \lambda)}{2} \quad \text{mn}(x, y, \mu, \lambda) = x + y - \text{mx}(x, y, \mu, \lambda).$$

For any $x \in \mathbb{R}^n$ and $\delta \in]0, 1]$ define:

$$\text{mx}_\delta(x) = \text{mx}(x_1, \text{mx}(\dots, \text{mx}(x_{n-1}, x_n, 1, (n\delta)^{-1}) \dots)).$$

Lemma 42 (Max/Min function) For any $x, y \in \mathbb{R}$ and $\lambda, \mu > 0$ we have:

$$\max(x, y) \leq \text{mx}(x, y, \mu, \lambda) \leq \max(x, y) + \min\left(\frac{1}{1 + \lambda\mu}, e^{-|x-y|\lambda\mu}\right)$$

and

$$\min(x, y) - \min\left(\frac{1}{1 + \lambda\mu}, e^{-|x-y|\lambda\mu}\right) \leq \text{mn}(x, y, \mu, \lambda) \leq \min(x, y)$$

So in particular, if $|x - y| \geq \lambda^{-1}$ then $\max(x, y) \leq \text{mx}(x, y, \mu, \lambda) \leq \max(x, y) + e^{-\mu}$ and $\min(x, y) - e^{-\mu} \leq \text{mn}(x, y, \mu, \lambda) \leq \min(x, y)$. Furthermore $\text{mx}, \text{mn} \in \text{GVAL}[\text{poly}]$. For any $x \in \mathbb{R}^n$ and $\delta \in]0, 1]$ we have:

$$\max(x_1, \dots, x_n) \leq \text{mx}_\delta(x) \leq \max(x_1, \dots, x_n) + \delta$$

Furthermore $\text{mx}_\delta \in \text{GVAL}[\text{poly}]$.

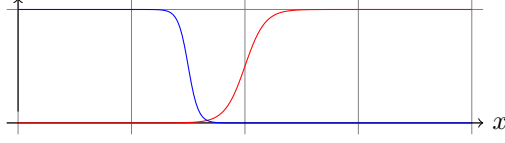

Figure 8: Graph of $\text{lhx}_{[1,3]}$ and $\text{hxl}_{[1,2]}$

Proof. By Lemma 40, $|y-x| \leq \text{abs}(y-x, \mu, \lambda) \leq |y-x| + \min\left(\frac{1}{1+\lambda\mu}, e^{-|x-y|\lambda\mu}\right)$ and the result follows because $\max(x, y) = \frac{y+x+|y-x|}{2}$. The result on mn follows the one on mx . Finally $\text{mx}, \text{mn} \in \text{GVAL}[\text{poly}]$ from Lemma 24.

Observe that $\max(x) \leq \text{mx}_\delta(x)$ is trivial by definition. The other inequality is a simple calculus based on $\max(x, y, \mu, \lambda) \leq \max(x, y) + \frac{1}{1+\mu\lambda}$:

$$\text{mx}_\delta(x) \leq \max(x) + n \frac{1}{1 + (n\delta)^{-1}} \leq \max(x) + \delta.$$

Note that strictly speaking, for $\text{mx}_\delta \in \text{GVAL}_{\mathbb{K}}[\text{poly}]$ we need that $\delta \in \mathbb{K}$ or use a smaller δ' in \mathbb{K} which is always possible. ■

Definition 43 (Norm function) For any $x \in \mathbb{R}^n$ and $\delta \in]0, 1]$ define:

$$\text{norm}_{\infty, \delta}(x) = \text{mx}_{\delta/2}(\text{abs}_{\delta/2}(x_1), \dots, \text{abs}_{\delta/2}(x_n))$$

where $\text{abs}_\delta(x) = \text{mx}_\delta(x, -x)$.

Lemma 44 (Norm function) For any $x \in \mathbb{R}^n$ and $\delta \in]0, 1]$ we have:

$$\|x\| \leq \text{norm}_{\infty, \delta}(x) \leq \|x\| + \delta$$

Furthermore $\text{norm}_{\infty, \delta} \in \text{GVAL}[\text{poly}]$.

Proof. Apply Lemma 40 and Lemma 42. ■

5.3 Switching functions

An important construct in digital computation is the “if ... then ... else ...” construct, which allows us to switch between two different behaviours. Again, this cannot be done exactly with a GPAC since GPACs cannot generate discrete functions and we need something which acts like a select function, which can pick between two values depending on how a third value compares to a threshold. The problem is that this operation is not continuous, and thus not generable. But such a select function can be approximated by a GPAC. As a good first step, we build so-called “low-X-high” and “high-X-low” functions which act as a switch between 0 (low) and a value (high). Around the threshold will be an small uncertainty zone (X) where the exact value cannot be predicted. See Figure 8 for a graphical representation.

Definition 45 (“low-X-high” and “high-X-low”) Let $I = [a, b]$ with $b > a$, $t \in \mathbb{R}$, $\mu \in \mathbb{R}$, $x \in \mathbb{R}$, $\nu = \mu + \ln(1 + x^2)$, $\delta = \frac{b-a}{2}$ and define:

$$\text{lhx}_I(t, \mu, x) = \text{ip}_1\left(t - \frac{a+b}{2} + 1, \nu, \frac{1}{\delta}\right) x$$

$$\text{hxl}_I(t, \mu, x) = \text{ip}_1 \left(\frac{a+b}{2} - t + 1, \nu, \frac{1}{\delta} \right) x$$

Lemma 46 (“low-X-high” and “high-X-low”) *Let $I = [a, b]$, $\mu \in \mathbb{R}_{\geq 0}$, then $\forall t, x \in \mathbb{R}$:*

- $\exists \phi_1, \phi_2$ such that $\text{lxh}_I(t, \mu, x) = \phi_1(t, \mu, x)x$ and $\text{hxl}_I(t, \mu, x) = \phi_2(t, \mu, x)x$
- if $t \leq a$, $|\text{lxh}_I(t, \mu, x)| \leq e^{-\mu}$ and $|x - \text{hxl}_I(t, \mu, x)| \leq e^{-\mu}$
- if $t \geq b$, $|x - \text{lxh}_I(t, \mu, x)| \leq e^{-\mu}$ and $|\text{hxl}_I(t, \mu, x)| \leq e^{-\mu}$
- in all cases, $|\text{lxh}_I(t, \mu, x)| \leq |x|$ and $|\text{hxl}_I(t, \mu, x)| \leq |x|$

Furthermore, $\text{lxh}_I, \text{hxl}_I \in \text{GVAL}[\text{poly}]$.

Proof. By symmetry, we only prove it for lxh . This is a direct consequence of Corollary 36 and the fact that $|x| \leq e^{\ln(1+x^2)}$. Indeed if $t \leq a$ then $t - \frac{a+b}{2} + 1 \leq 1 - \delta$ thus $|\text{lxh}_I(t, \nu, x)| \leq |x|e^{-\nu} \leq e^{-\mu}$. Similarly if $t \geq b$ then $t - \frac{a+b}{2} + 1 \geq 1 + \delta$ and we get a similar result. Apply Lemma 24 multiple times to see that they are belong to $\text{GVAL}[\text{poly}]$. ■

5.4 GPAC approximation

The examples of the previous section all share an interesting common pattern, which we formalise with the definition below. In this section, \mathbb{K} can be any generable field⁵.

Definition 47 (GPAC approximation) *Let I be an open and connected subset of \mathbb{R}^m , $\Gamma \subseteq I$ a subset of I of exceptions and $f : I \rightarrow \mathbb{R}^m$. We say that f is GPAC-approximable over I but Γ if there exists $g \in \text{GVAL}_{\mathbb{K}}[\text{poly}]$ such that for any $x \in I$ and $\mu, \lambda > 0$ we have*

$$\|f(x) - g(x, \mu, \lambda)\| \leq e^{-\mu} \quad \text{if} \quad d(x, \Gamma) \geq \lambda^{-1},$$

where $d(x, \Gamma)$ denotes the distance between x and Γ (for the infinite norm).

The set Γ of points where the approximation fails will typically be discrete, finite or even empty. If Γ is empty, we do not mention it and say f is GPAC-approximable. Intuively, g provides an *effective*, uniform and arbitrary good approximation of f , except on a set that can be made “arbitrary small”. We cannot quantify how small the set of exception is in general, since the definition allows for pathological cases such as $\Gamma = I$ or $\Gamma = I \cap \mathbb{Q}^m$. However, in case where Γ is discrete, a condition met by all examples in this paper, for any compact set K , the measure of exception set $\{d(x, \Gamma) \leq \lambda^{-1}\} \cap K$ converges to 0 as λ tends to infinity.

Note that our notion of approximation is not really related to classical approximation theory, by a sequence of functions for example. Indeed, in the definition, the same function g is used for all μ and λ , which creates a lot of constraints since g is generable, i.e. it satisfies a polynomial partial differential equation. Informally, one can think of g as a “template” with parameters μ and

⁵See Section 6 for more details.

λ that we can tweak to get closer and closer to f but the shape itself of the template is fixed once and for all.

It appears that there is an interesting trade-off between the bound \mathbf{sp} on the norm of g (i.e. $g \in \text{GVAL}[\mathbf{sp}]$) and the quality of the approximation. Indeed, if \mathbf{sp} is chosen to be a polynomial, we can seemingly achieve an exponential error bound ($e^{-\mu}$) but only an inverse distance from Γ ($1/\lambda$) for interesting functions. For simplicity, we only consider polynomially bounded generable functions in this definition.

Note that the definition does not mandate that f be continuous and indeed it needs not be. For example, Lemma 38 proves that the rounding function is GPAC-approximable over \mathbb{R} but $\frac{1}{2} + \mathbb{Z}$. More generally, the discontinuity points will always belong to Γ .

In this section, we give several examples of classes of functions that can be approximated as described above.

Lemma 48 (Basic approximable functions) *Any generable function is approximable on its domain of definition. If f and g are GPAC-approximable over X but Γ_f and Γ_g respectively, then $f \pm g$ and fg are GPAC-approximable over X but $\Gamma_f \cup \Gamma_g$.*

Proof. Any generable function trivially satisfies the definition using itself as an approximation. If f is approximated by F and g by G then for any $\mu, \lambda > 0$ and $x \in X$ such that $d(x, \Gamma_f \cup \Gamma_g) \geq \lambda^{-1}$:

$$\|f(x) + g(x) - F(x, \mu + 1, \lambda) - G(x, \mu + 1, \lambda)\| \leq 2e^{-\mu-1} \leq e^{-\mu}.$$

Thus $(x, \mu, \lambda) \mapsto F(x, \mu + 1, \lambda) + G(x, \mu + 1, \lambda)$ approximate $f + g$ over X but $\Gamma_f \cup \Gamma_g$.

The case of the multiplication is similar but slightly more involved. Define for any $x \in X$ and $\mu, \lambda > 0$:

$$H(x, \mu, \lambda) = \underbrace{F(x, \mu + 2 + \text{norm}_{\infty,1}(G(x, 1, \lambda)), \lambda)}_{:=\tilde{f}(x, \mu, \lambda)} \underbrace{G(x, \mu + 3 + \text{norm}_{\infty,1}(F(x, 1, \lambda)), \lambda)}_{:=\tilde{g}(x, \mu, \lambda)}.$$

It will be useful to recall that $\|x\| \leq \text{norm}_{\infty,1}(x)$ thanks to Lemma 44. Let $\mu, \lambda > 0$ and $x \in X$ such that $d(x, \Gamma_f \cup \Gamma_g) \geq \lambda^{-1}$. Note that since we have $\|f(x) - F(x, 1, \lambda)\| \leq e^{-1}$ then $\|F(x, 1, \lambda)\| \geq \|f(x)\| - 1$. Similarly, $\|\tilde{g}(x, \mu, \lambda) - G(x, 1, \lambda)\| \leq e^{-1} + e^{-\mu}$ thus $\|G(x, 1, \lambda)\| \geq \|\tilde{g}(x, \mu, \lambda)\| - 2$. Finally check that $x \mapsto xe^{-x}$ is globally bounded by 1. Thus we have:

$$\begin{aligned} \|f(x)g(x) - H(x, \mu, \lambda)\| &\leq \|f(x)\| \|g(x) - \tilde{g}(x, \mu, \lambda)\| \\ &\quad + \left\| f(x) - \tilde{f}(x, \mu, \lambda) \right\| \|\tilde{g}(x, \mu, \lambda)\| \\ &\leq \|f(x)\| e^{-\mu-2-\text{norm}_{\infty,1}(F(x,1,\lambda))} \\ &\quad + e^{-\mu-3-\text{norm}_{\infty,1}(G(x,1,\lambda))} \|\tilde{g}(x, \mu, \lambda)\| \\ &\leq \|f(x)\| e^{-\mu-1-\|f(x)\|} + e^{-\mu-1-\|\tilde{g}(x,\mu,\lambda)\|} \|\tilde{g}(x, \mu, \lambda)\| \\ &\leq 2e^{-\mu-1} \leq e^{-\mu}. \end{aligned}$$

This shows that H approximates fg over x but $\Gamma_f \cup \Gamma_g$. The fact that $H \in \text{GVAL}[\text{poly}]$ follows from the hypothesis on F and G and Lemma 24. ■

Theorem 49 (Piecewise approximability) *Let $-\infty \leq a_0 < a_1 < \dots < a_{k+1} \leq +\infty$ and $f :]a_0, a_{k+1}[\rightarrow \mathbb{R}$. Assume that for each $i \in \{0, \dots, k\}$, f is GPAC-approximable over $]a_i, a_{i+1}[$ but Γ_i . Further assume that all finite a_i belong to \mathbb{K} . Then f is GPAC-approximable over $]a_0, a_{k+1}[$ but $\{a_1, \dots, a_k\} \cup \bigcup_{i=0}^k \Gamma_i$.*

Proof. Without loss of generality, we can assume that f is defined over \mathbb{R} . Indeed if f is only defined over $[a, b]$, $[a, +\infty[$ or $] -\infty, b]$, we can add an extra infinite interval over which f is constantly equal to 0. The resulting g for this extended f satisfies the definition over the original domain of definition of f .

We now assume that $a_0 = -\infty$ and $a_{k+1} = +\infty$. Let $\tilde{f}_i \in \text{GVAL}[\text{poly}]$ be the GPAC-approximation of f over $]a_i, a_{i+1}[$ but Γ_i , for $i \in \{0, \dots, k\}$. There is a subtle issue at this point: a priori \tilde{f}_i is only defined over $]a_i, a_{i+1}[\times]0, +\infty[^2$. We will show that \tilde{f}_i can be assumed to be defined over $\mathbb{R} \times]0, +\infty[^2$ and we defer of proof of this fact to end of this proof. Define for any $x \in \mathbb{R}$, $\mu \geq 0$ and $\lambda > 0$:

$$g(x, \mu, \lambda) = \tilde{f}_0(x, \nu, \lambda) + \sum_{i=1}^k \text{lxh}_{[-1,1]}((x - a_i)\lambda, \nu, \tilde{f}_i(x, \nu, \lambda) - \tilde{f}_{i-1}(x, \nu, \lambda))$$

where $\nu = \mu + k + 1$. First note that $g \in \text{GVAL}_{\mathbb{K}}[\text{poly}]$ because it is a finite sum of generable functions in $\text{GVAL}[\text{poly}]$, and the endpoints of the intervals belong to \mathbb{K} . Define $\Gamma = \{a_1, \dots, a_k\} \cup \bigcup_{i=0}^k \Gamma_i$. Let $\mu, \lambda > 0$ and $x \in \mathbb{R}$ be such that $d(x, \Gamma) \geq \lambda^{-1}$. It follows that $a_i + \lambda^{-1} \leq x \leq a_{i+1} - \lambda^{-1}$ for some $i \in \{0, \dots, k\}$. Let $j \in \{0, \dots, k\}$ and apply Lemma 46 to get that $|\text{lxh}_{[-1,1]}((x - a_j)\lambda, \nu, X)| \leq e^{-\nu}$ if $j \geq i + 1$ and $|\text{lxh}_{[-1,1]}((x - a_j)\lambda, \nu, X) - X| \leq e^{-\nu}$ if $j \leq i$. It follows that:

$$\begin{aligned} |g(x, \mu, \lambda) - f(x)| &\leq \left| g(x, \mu, \lambda) - \tilde{f}_i(x, \nu, \lambda) \right| + e^{-\nu} \\ &= \left| g(x, \mu, \lambda) - \tilde{f}_0(x, \nu, \lambda) - \sum_{j=1}^i \left(\tilde{f}_j(x, \nu, \lambda) - \tilde{f}_{j-1}(x, \nu, \lambda) \right) \right| \\ &\leq \sum_{j=1}^i \left(\text{lxh}_{[-1,1]}((x - a_j)\lambda, \nu, \tilde{f}_j(x, \nu, \lambda) - \tilde{f}_{j-1}(x, \nu, \lambda)) \right. \\ &\quad \left. - \left(\tilde{f}_j(x, \nu, \lambda) - \tilde{f}_{j-1}(x, \nu, \lambda) \right) \right) + e^{-\nu} \\ &\leq (k + 1)e^{-\nu} \leq e^{-\mu}. \end{aligned}$$

This concludes the proof that f is approximate by g over \mathbb{R} but Γ . It remains to show that, indeed, each \tilde{f}_i can be assumed to be defined over \mathbb{R} . We show this in full-generality for intervals.

Let $f :]a, b[\rightarrow \mathbb{R}$ and $\tilde{f} :]a, b[\times]0, +\infty[^2$ a GPAC-approximation of f . Let sp be a polynomial such that $\tilde{f} \in \text{GVAL}[\text{sp}]$. Apply Proposition 28 to \tilde{f} to get a polynomial q . Recall that q acts as a modulus of continuity:

$$\left| \tilde{f}(x, \mu, \lambda) - \tilde{f}(y, \mu, \lambda) \right| \leq |x - y|q(\text{sp}(\max(|x|, |y|, \mu, \lambda)))$$

for any $x, y \in]a, b[$ and $\mu, \lambda > 0$. Let $p \in \mathbb{K}[\mathbb{R}]$ be a nondecreasing polynomial such that $p(x) \geq q(\text{sp}(x))$ for all $x \geq 0$. Define for any $x \in \mathbb{R}$ and $\mu, \lambda > 0$:

$$\text{clamp}(x, \mu, \lambda) = \text{mx}(a + \theta^{-1}, \text{mn}(x, b - \theta^{-1}, \mu + 1, \theta), \mu + 1, \theta)$$

where $\delta = b - a$ and $\theta = 2\lambda + (2\delta)^{-1}$. Observe that clamp satisfies three key properties:

- $\text{clamp}(x, \mu, \lambda) \in]a, b[$ for all $x \in \mathbb{R}$ and $\mu, \lambda > 0$: indeed, by Lemma 42, $\text{clamp}(x, \mu, \lambda) \geq a + \theta^{-1} > a$. On the other hand, $\text{clamp}(x, \mu, \lambda) \leq \max(a + \theta^{-1}, \text{mn}(x, b, \mu + 1, \theta)) + \frac{1}{1 + (1 + \mu)\theta}$ but $\text{mn}(\text{mn}(x, b - \theta^{-1}, \mu + 1, \theta)) \leq b - \theta^{-1}$ so $\text{clamp}(x, \mu, \lambda) \leq \max(a + \theta^{-1}, b - \theta^{-1}) + \frac{1}{1 + (1 + \mu)\theta}$. Note that $\theta > (2\delta)^{-1}$ so $a + \theta^{-1} < b - \theta^{-1}$. Consequently $\text{clamp}(x, \mu, \lambda) \leq b - \theta^{-1} + \frac{1}{1 + (1 + \mu)\theta} < b$.
- if $a + \lambda^{-1} \leq x \leq b - \lambda^{-1}$ then $|\text{clamp}(x, \mu, \lambda) - x| \leq e^{-\mu}$: if $a + \lambda^{-1} \leq x$ then $x - (a + \theta^{-1}) - \theta^{-1} \geq \lambda^{-1} - 2\theta^{-1} \geq 0$ so $|\text{clamp}(x, \mu, \lambda) - \text{mn}(x, b - \theta^{-1}, \mu + 1, \theta)| \leq e^{-\mu - 1}$. Similarly, $x \leq b - \lambda^{-1}$ implies that $x \leq (b - \theta^{-1}) - \theta^{-1}$ so $|\text{mn}(x, b - \theta^{-1}, \mu + 1, \theta) - x| \leq e^{-\mu - 1}$. It follows that $|\text{clamp}(x, \mu, \lambda) - x| \leq 2e^{-\mu - 1} \leq e^{-\mu}$.
- $\text{clamp} \in \text{GVAL}[\text{poly}]$: use Lemma 42 and the usual arithmetic lemmas. Note that it works because $\lambda \mapsto (2\lambda + (2\delta)^{-1})^{-1}$ belongs to $\text{GVAL}[\text{poly}]$ for any fixed δ .

We can now use clamp to make sure the argument of \tilde{f} is always within the domain of definition $]a, b[$, and make sure that it is a good enough approximation using the modulus of continuity. Define for any $x \in \mathbb{R}$ and $\mu, \lambda > 0$:

$$\tilde{F}(x, \mu, \lambda) = \tilde{f}(\text{clamp}(x, \mu + 1 + p(1 + \text{norm}_{\infty, 1}(x, \mu, \lambda)), \lambda), \mu + 1, \lambda)$$

Clearly $\tilde{F} \in \text{GVAL}[\text{poly}]$. Let $\mu, \lambda > 0$ and $x \in]a, b[$ such that $d(x, \Gamma \cup \{a, b\}) \geq \lambda^{-1}$. It follows from the results above that:

$$\begin{aligned} |f(x) - \tilde{F}(x, \mu, \lambda)| &\leq |f(x) - \tilde{f}(x, \mu + 1, \lambda)| + |\tilde{F}(x, \mu, \lambda) - \tilde{f}(x, \mu + 1, \lambda)| \\ &\leq e^{-\mu - 1} + |x - \text{clamp}(x, \mu + 1 + p(1 + \text{norm}_{\infty, 1}(x, \mu, \lambda)), \lambda)| \\ &\quad \times p(\max(|x|, \\ &\quad |\text{clamp}(x, \mu + 1 + p(1 + \text{norm}_{\infty, 1}(x, \mu, \lambda)), \lambda)|, \mu + 1, \lambda)) \\ &\leq e^{-\mu - 1} + e^{-\mu - 1 - p(1 + \text{norm}_{\infty, 1}(x, \mu, \lambda))} \\ &\quad \times p(\max(|x|, |x| + e^{-\mu - 1 - p(1 + \text{norm}_{\infty, 1}(x, \mu, \lambda))}, \mu + 1, \lambda)) \\ &\leq e^{-\mu - 1} \\ &\quad + e^{-\mu - 1 - p(\max(1 + |x|, \mu + 1, \lambda))} p(\max(|x|, |x| + 1, \mu + 1, \lambda)) \\ &\leq 2e^{-\mu - 1} \leq e^{-\mu} \end{aligned}$$

■

Theorem 50 (Periodic approximability) *Let $f : \mathbb{R} \rightarrow \mathbb{R}$ be a τ -periodic function. Assume that there exists $a, b \in \mathbb{K}$ such that $b - a = \tau$ and f is GPAC-approximable over $]a, b[$ but Γ . Then f is GPAC-approximable over \mathbb{R} but $(\Gamma \cup \{a, b\}) + \tau\mathbb{Z}$.*

Proof. First note that we can assume that $a + b = 0$: define $g(x) = f(x + \delta)$ where $\delta = \frac{a+b}{2}$, take a GPAC-approximation \tilde{f} of f over $]a, b[$ but Γ . Observe

that $\tilde{g}(x, \mu, \lambda) = \tilde{f}(x + \delta, \mu, \lambda)$ provides an approximation of g over $]a - \delta, b - \delta[$ but $\Gamma - \delta$. Then f is approximable over \mathbb{R} but $(\Gamma \cup \{a, b\}) + \tau\mathbb{Z}$ if and only if g is approximable over \mathbb{R} but $((\Gamma - \delta) \cup \{a - \delta, b - \delta\}) + \tau\mathbb{Z}$. Now observe that $(a - \delta) + (b - \delta) = a + b - 2\delta = 0$.

For a similar reason, we can assume that $\tau = 1$ by rescaling x . It follows that we can assume that $a = -1/2$ and $b = 1/2$. Let \tilde{f} be a GPAC-approximation of f over $] \frac{-1}{2}, \frac{1}{2}[$ but Γ . We use the same trick as in Theorem 49 to ensure that \tilde{f} is defined over $\mathbb{R} \times]0, +\infty[^2$. Let \mathbf{sp} be a polynomial such that $\tilde{f} \in \text{GVAL}[\mathbf{sp}]$. Apply Proposition 28 to \tilde{f} to get a polynomial q . Recall that q acts as a modulus of continuity:

$$\left| \tilde{f}(x, \mu, \lambda) - \tilde{f}(y, \mu, \lambda) \right| \leq |x - y|q(\mathbf{sp}(\max(|x|, |y|, \mu, \lambda)))$$

for any $x, y \in]a, b[$ and $\mu, \lambda > 0$. Let $p \in \mathbb{K}[\mathbb{R}]$ be a nondecreasing polynomial such that $p(x) \geq q(\mathbf{sp}(x))$ for all $x \geq 0$. Define for any $x \in \mathbb{R}$ and $\mu, \lambda > 0$:

$$\tilde{F}(x, \mu, \lambda) = \tilde{f}(x - \text{rnd}(x, \mu + 1 + p(1 + \text{norm}_{\infty,1}(\mu, \lambda))), \mu + 1, \lambda)$$

Clearly $\tilde{F} \in \text{GVAL}[\text{poly}]$. Let $\mu, \lambda > 0$ and $x \in]a, b[$ such that $d(x, (\Gamma \cup \{a, b\}) + \tau\mathbb{Z}) \geq \lambda^{-1}$. It follows that there exists $n \in \mathbb{Z}$ such that $x = n + u$ where $u \in] \frac{-1}{2} + \lambda^{-1}, \frac{1}{2} - \lambda^{-1}[$ and $d(u, \Gamma) \geq \lambda^{-1}$. Apply Lemma 38 to get that $|\text{rnd}(x, \mu + 1 + p(1 + \text{norm}_{\infty,1}(\mu, \lambda)), \lambda) - n| \leq e^{-\mu-1-p(1+\text{norm}_{\infty,1}(\mu,\lambda))}$ so in particular $|x - \text{rnd}(x, \mu + 1 + p(1 + \text{norm}_{\infty,1}(\mu, \lambda)), \lambda) - u| \leq e^{-\mu-1-p(1+\text{norm}_{\infty,1}(\mu,\lambda))}$. In particular, $|x - \text{rnd}(x, \mu + 1 + p(1 + \text{norm}_{\infty,1}(\mu, \lambda)), \lambda)| \leq 1$. It follows that:

$$\begin{aligned} \left| f(x) - \tilde{F}(x, \mu, \lambda) \right| &\leq \left| f(x) - \tilde{f}(u, \mu + 1, \lambda) \right| + \left| \tilde{F}(x, \mu, \lambda) - \tilde{f}(u, \mu + 1, \lambda) \right| \\ &\leq \left| f(x - n) - \tilde{f}(u, \mu + 1, \lambda) \right| \\ &\quad + |x - \text{rnd}(x, \mu + 1 + p(1 + \text{norm}_{\infty,1}(\mu, \lambda)), \lambda) - u| \\ &\quad \times p(\max(|u|, \\ &\quad |x - \text{rnd}(x, \mu + 1 + p(1 + \text{norm}_{\infty,1}(\mu, \lambda)), \lambda)|, \mu + 1, \lambda)) \\ &\leq e^{-\mu-1} + e^{-\mu-1-p(1+\text{norm}_{\infty,1}(\mu,\lambda))} p(\max(1, 1, \mu + 1, \lambda)) \\ &\leq e^{-\mu-1} + e^{-\mu-1-p(\max(1, \mu+1, \lambda))} p(\max(1, \mu + 1, \lambda)) \\ &\leq 2e^{-\mu-1} \leq e^{-\mu} \end{aligned}$$

■

6 Generable fields

In Section 2, we introduced the notion of *generable field*, which are fields with an additional stability property. We used this notion to ensure that the class of functions we built is closed under composition. It is well-known that if we allow any choice of constants in our computation, we will gain extra computational power because of uncomputable real numbers. For this reason, it is wise to make sure that we can exhibit at least one generable field consisting of computable real numbers only, and possibly only polynomial time computable numbers in the sense of computable analysis [BHW08].

Intuitively, we are looking for a (the) smallest generable field, call it \mathbb{R}_G , in order to minimize the computation power of the real numbers it contains. The rest of this section is dedicated to the study of this field. We first recall Definition 9.

Definition 51 (Generable field) *A field \mathbb{K} is generable if and only if $\mathbb{Q} \subseteq \mathbb{K}$ and for any $\alpha \in \mathbb{K}$, and $(f : \mathbb{R} \rightarrow \mathbb{R}) \in \text{GVAL}_{\mathbb{K}}$, $f(\alpha) \in \mathbb{K}$.*

6.1 Extended stability

By definition of a generable field, \mathbb{K} is preserved by unidimensional generable functions. An interesting question is whether \mathbb{K} is also preserved by multidimensional functions. This is not immediate because because of several key differences in the definition of multidimensional generable functions. We first recall a folklore topology lemma.

Lemma 52 (Offset of a compact set) *Let $X \subseteq U \subseteq \mathbb{R}^n$ where U is open and X is compact. Then there exists $\varepsilon > 0$ such that $X_\varepsilon \subseteq U$ where the ε -offset of X is defined by $X_\varepsilon = \bigcup_{x \in X} B_\varepsilon(x)$.*

Proof. This is a very classical result: let $F = \mathbb{R}^n \setminus U$, then F is closed so the distance function⁶ d_F to F is continuous. Since X is compact, $d_F(X)$ is a compact subset of $\mathbb{R}_{\geq 0}$, and $d_F(X)$ is nowhere 0 because $X \subseteq U \subseteq F$ where U is open. Consequently $d_F(X)$ admits a positive minimum ε . Let $x \in X_\varepsilon$, then $\exists y \in X$ such that $\|x - y\| < \varepsilon$, and by the triangle inequality, $\varepsilon \leq d_F(y) \leq \|x - y\| + d_F(x)$ so $d_F(x) > 0$ which means $x \notin F$, in other words $x \in U$. ■

Lemma 53 (Polygonal path connectedness) *An open, connected subset U of \mathbb{R}^n is always polygonal-path-connected: for any $a, b \in U$, there exists a polygonal path⁷ from a to b in U . Furthermore, we can take all intermediate vertices in \mathbb{Q}^n .*

Proof. This is a textbook property, e.g. Theorem 3-5 in [HY88]. ■

Proposition 54 (Generable path connectedness) *An open, connected subset U of \mathbb{R}^n is always generable-path-connected: for any $a, b \in U \cap \mathbb{K}^n$, there exists $(\phi : \mathbb{R} \rightarrow U) \in \text{GVAL}_{\mathbb{K}}$ such that $\phi(0) = a$ and $\phi(1) = b$.*

Proof. Let $a, b \in U \cap \mathbb{K}^n$ and apply Lemma 53 to get a polygonal path $\gamma : [0, 1] \rightarrow U$ from a to b . We are going to build a highly smoothed approximation of γ . This is usually done using bump functions but bump functions are not analytic, which complicates the matter. Furthermore, we need to build a path which domain of definition is \mathbb{R} , although this will be a minor annoyance only. We ignore the case where $a = b$ which is trivial and focus on the case where $a \neq b$.

Let $X = \gamma([0, 1])$ which is a compact connected set. Apply Lemma 52 to get $\varepsilon > 0$ such that $X_\varepsilon \subseteq U$. Without loss of generality, we can assume that $\varepsilon \in \mathbb{Q}$ so that it is generable.

⁶We always use the infinite norm $\|\cdot\|$ in this paper but it works for any distance

⁷A polygonal path is a connected sequence of line segments

Assume for a moment that γ is trivial, that is γ is a line segment from a to b . Let $\alpha \in \mathbb{N} \subseteq \mathbb{K}$ such that $\frac{1}{\tanh(\alpha)} \leq 1 + \frac{2\varepsilon}{\|b-a\|}$. It exists because $\frac{1}{\tanh(x)} \xrightarrow{x \rightarrow \infty} 1$. Define $\phi(t) = a + \frac{1+\mu(t)}{2}(b-a)$ where $\mu(t) = \frac{\tanh((2t-1)\alpha)}{\tanh(\alpha)}$. One can check that μ is an increasing function and that $\mu(0) = -1$ and $\mu(1) = 1$. Furthermore, if $t > 1$, $|\mu(t) - 1| < \frac{2\varepsilon}{\|b-a\|}$, and conversely, if $t < 0$, $|\mu(t) + 1| < \frac{2\varepsilon}{\|b-a\|}$. Consequently, $\phi(0) = a$, $\phi(1) = b$ and $\phi([0, 1])$ is the line segment between a and b , so $\phi([0, 1]) \subseteq X$. Furthermore, if $t < 0$, $\|a - \phi(t)\| \leq \left| \frac{1+\mu(t)}{2} \right| \|b-a\| < \varepsilon$, and if $t > 1$, $\|b - \phi(t)\| \leq \left| \frac{1-\mu(t)}{2} \right| \|b-a\| < \varepsilon$. We conclude from this analysis that $\phi(\mathbb{R}) \subseteq X_\varepsilon \subseteq U$. It remains to show that $\phi \in \text{GVAL}_{\mathbb{K}}$. Using Lemma 11, it suffices to show that $\tanh \in \text{GVAL}_{\mathbb{K}}$ and $\frac{1}{\tanh(\alpha)} \in \mathbb{K}$. Since \mathbb{K} is a field, we need to show that $\tanh(\alpha) \in \mathbb{K}$ which is a consequence of \mathbb{K} being a generable field and \tanh being a generable function. We already saw in Example 7 that $\tanh \in \text{GVAL}_{\mathbb{Q}} \subseteq \text{GVAL}_{\mathbb{K}}$.

In the general case where γ is a polygonal path, there are $0 = t_1 < t_2 < \dots < t_k = 1$ such that $\gamma \upharpoonright_{[t_i, t_{i+1}]}$ is the line segment between $x_i = \gamma(t_i)$ and $x_{i+1} = \gamma(t_{i+1})$, furthermore we can always take $x_i \in \mathbb{Q}^n$. Note that we can choose any parametrization for the path so in particular we can take $t_i = \frac{i}{k}$ and ensure that $t_i \in \mathbb{Q}$ for $i \in \llbracket 0, k \rrbracket$. Since by hypothesis $x_0, x_n \in \mathbb{K}^n$, we get that $x_i \in \mathbb{K}^n$ and $t_i \in \mathbb{K}$ for all $i \in \llbracket 0, k \rrbracket$.

Let us denote by $\phi_\varepsilon^{a,b}$ the path built in the previous case. We are simply going to add several instances of this path, with the necessary shifting and scaling. Since the errors will sum up, we will increase the approximation precision of each segment. Define $\phi(t) = a + \sum_{i=1}^{k-1} \left(\phi_{\varepsilon/k}^{x_i, x_{i+1}} \left(\frac{t-t_i}{t_{i+1}-t_i} \right) - x_i \right)$ and consider the following cases:

- if $t < 0$, then $\left\| \phi_{\varepsilon/k}^{x_i, x_{i+1}} \left(\frac{t-t_i}{t_{i+1}-t_i} \right) - x_i \right\| < \frac{\varepsilon}{k}$ for all $i \in \llbracket 1, k-1 \rrbracket$, so $\|a - \phi(t)\| < \frac{k-1}{k}\varepsilon$ and $\phi(t) \in X_\varepsilon$
- if $t \in [t_j, t_j + 1]$ for some j , then $\left\| \phi_{\varepsilon/k}^{x_i, x_{i+1}} \left(\frac{t-t_i}{t_{i+1}-t_i} \right) - x_i \right\| < \frac{\varepsilon}{k}$ for all $i > j$, and conversely $\left\| \phi_{\varepsilon/k}^{x_i, x_{i+1}} \left(\frac{t-t_i}{t_{i+1}-t_i} \right) - x_{i+1} \right\| < \frac{\varepsilon}{k}$ for all $i < j$. Finally $u = \phi_{\varepsilon/k}^{x_j, x_{j+1}} \left(\frac{t-t_j}{t_{j+1}-t_j} \right)$ belongs to the line segment from x_j to x_{j+1} . Since $a = x_1$, we get that $\|u - \phi(t)\| \leq \frac{k-1}{k}\varepsilon$ and thus $\phi(t) \in X_\varepsilon$.
- if $t > 1$ then $\|b - \phi(t)\| < \varepsilon$ for the same reason as $t < 0$, and thus $\phi(t) \in X_\varepsilon$.

We conclude that $\phi(\mathbb{R}) \subseteq X_\varepsilon \subseteq U$ and one easily checks that $\phi(0) = a$ and $\phi(1) = b$. Furthermore $\phi \in \text{GVAL}_{\mathbb{K}}$ by Lemma 11 and because the x_i and t_i belong to \mathbb{K} (see the details in the case of the trivial path). ■

The immediate corollary of this result is that \mathbb{K} is also preserved by multidimensional generable functions. Indeed, by composing a multidimensional function with a unidimensional one, we get back to the unidimensional case and conclude that any generable point in the input domain must have a generable image.

Corollary 55 (Generable field stability) *Let $(f : \subseteq \mathbb{R}^d \rightarrow \mathbb{R}^\ell) \in \text{GVAL}_{\mathbb{K}}$, then $f(\mathbb{K}^d \cap \text{dom } f) \subseteq \mathbb{K}^\ell$.*

Proof. Apply Definition 14 to get $n \in \mathbb{N}$, $p \in M_{n,d}(\mathbb{K})[\mathbb{R}^n]$, $x_0 \in \text{dom } f \cap \mathbb{K}^d$, $y_0 \in \mathbb{K}^n$ and $y : \text{dom } f \rightarrow \mathbb{R}^n$. Let $u \in \text{dom } f \cap \mathbb{K}^d$. Since $\text{dom } f$ is open and connected, by Proposition 54, there exists $(\gamma : \mathbb{R} \rightarrow \text{dom } f) \in \text{GVAL}$ such that $\gamma(0) = x_0$ and $\gamma(1) = u$. Apply Definition 14 to γ to get $\bar{n} \in \mathbb{N}$, $\bar{p} \in M_{\bar{n},1}(\mathbb{K})[\mathbb{R}^{\bar{n}}]$, $\bar{x}_0 \in \mathbb{K}$, $\bar{y}_0 \in \mathbb{K}^{\bar{n}}$ and $\bar{y} : \mathbb{R} \rightarrow \mathbb{R}^{\bar{n}}$. Define $z(t) = y(\gamma(t)) = y(\bar{y}_{1..d}(t))$, then $z'(t) = J_y(\gamma(t))\gamma'(t) = p(y(\gamma(t)))\gamma'(t) = p(z(t))\bar{p}_{1..d}(\bar{y}(t))$ and $z(0) = y(\gamma(0)) = y(x_0) = y_0$. In other words (\bar{y}, z) satisfy:

$$\begin{cases} \bar{y}(0) = x_0 \in \mathbb{K}^d \\ z(0) = y_0 \in \mathbb{K}^n \end{cases} \quad \begin{cases} \bar{y}' = \bar{p}(\bar{y}) \\ z' = p(z)\bar{p}_{1..d}(\bar{y}) \end{cases}$$

Consequently $(z : \mathbb{R} \rightarrow \mathbb{R}^\ell) \in \text{GVAL}$ so, by definition of a generable field, $z(\mathbb{K}) \subseteq \mathbb{K}^z \text{ell}$. Conclude by noticing that $z(1) = y(\gamma(1)) = y(u)$. ■

6.2 Generable real numbers

In this section, we formalize the notion of generable field with an operator and study its properties. Recall that the smallest field we are looking for is a subset of \mathbb{R} but it must also contains \mathbb{Q} . We consider the following operator G on subset of real numbers.

$$G : \begin{cases} \mathcal{P}(\mathbb{R}) & \rightarrow & \mathcal{P}(\mathbb{R}) \\ X & \mapsto & \bigcup_{f \in \text{GVAL}_X} f(X) \end{cases}$$

Remark 56 (G monotone and non-decreasing) *One can check that G is monotone ($X \subseteq G(X)$ for any $X \subseteq \mathbb{R}$). Indeed for any $x \in X$, the constant function $u \mapsto x$ belongs to GVAL_X . Moreover, it is non-decreasing because $\text{GVAL}_X \subseteq \text{GVAL}_Y$ if $X \subseteq Y$.*

It is clear that by definition, a field is generable if and only if it is G -stable. An interesting property of G is that its definition can be simplified. More precisely, by rescaling the functions, we can always assume that the image of G is produced by the evaluation of generable functions at a particular point, say 1, instead of the entire field.

Lemma 57 (Alternative definition of G) *If X is a field then,*

$$G(X) = \{f(1) : f \in \text{GVAL}_X\}$$

Proof. Let $x \in G(X)$, then there exists $f \in \text{GVAL}_X$ and $t \in X$ such that $x = f(t)$. Consequently there exists $d \in \mathbb{N}$, $y_0 \in X^d$, $p \in X^d[\mathbb{R}^d]$ and $y : \mathbb{R} \rightarrow \mathbb{R}^d$ satisfying Definition 2:

- $y' = p(y)$ and $y(0) = y_0$
- $y_1 = f$

Consider $g(u) = f(ut)$ and note that $g(1) = f(t) = x$. We will see that $g \in \text{GVAL}_X$. Indeed, consider $z(u) = y(tu)$ then for all $u \in \mathbb{R}$:

- $z(0) = y(0) = y_0 \in X^d$;

- $z'(u) = ty'(tu) = tp(z(u)) = q(z(u))$ where $q = tp$ is a polynomial with coefficients in X since $t \in X$ and X is a field
- $z_1(u) = y_1(tu) = g(u)$

■

A consequence of this alternative definition is a simple proof that G preserves the property of being a field. This will turn out to be crucial fact later on.

Lemma 58 (G maps fields to fields) *If X is a field, then $G(X)$ is a field.*

Proof. Let $x, y \in G(X)$, by Lemma 57 there exists $f, g \in \text{GVAL}_X$ such that $x = f(1)$ and $y = g(1)$. Apply Lemma 11 to get that $f \pm g$ and fg belong to GVAL_X . And thus $x \pm y$ and xy belong to $G(X)$.

Finally the case of $\frac{1}{x}$ (when $x \neq 0$) is slightly more subtle: we cannot simply compute $\frac{1}{f}$ because f may cancel. Instead we are going to compute $\frac{1}{g}$ where $g(1) = f(1)$ but g never cancels.

First, note that we can always assume that $x > 0$ because $G(X)$ is closed under the negation, and $-\frac{1}{x} = \frac{1}{-x}$. Since $f(1) = x > 0$ and f is continuous, it means there exists $\varepsilon > 0$ such that $f(t) > 0$ for all $t \in [1 - \varepsilon, 1 + \varepsilon]$ and we can take $\varepsilon \in \mathbb{Q}$. Define $g(t) = f(t) + (1 + f(t)^2) \left(\frac{t-1}{\varepsilon}\right)^2$. It is not hard to see that $g(1) = f(1)$ and that $g(t) > 0$ for all $t \in \mathbb{R}$. Furthermore, $g \in \text{GVAL}_X$ because of Lemma 11. Note that we use the part of the lemma which does not assume that X is a generable field!

Using Lemma 11, we conclude that $\frac{1}{g} \in \text{GVAL}_X$ and thus $\frac{1}{x} \in G(X)$. ■

Not only G maps fields to fields, but it also preserves polynomial-time computability. This is of major interest to us to show that there exists a generable field with low complexity numbers. Here \mathbb{R}_P denotes the set of polynomial time computable real numbers [Ko91].

Lemma 59 (G preserves polytime computability) *G maps subsets of polynomial time computable real numbers into themselves, i.e. for any $X \subseteq \mathbb{R}_P$, $G(X) \subseteq \mathbb{R}_P$.*

Proof. Let $X \subseteq \mathbb{R}_P$ and $x \in G(X)$, $f \in \text{GVAL}_X$ and $t \in X$ such that $x = f(t)$. We can use [BGP12] to conclude that x is polynomial time computable, thus $x \in \mathbb{R}_P$. ■

Finally, the core of what makes G very special is its finiteness property. Essentially, it means that if $x \in G(X)$ then x really only requires a finite number of elements in X to be computed. In the framework of order and lattice theory, this shows that G is a Scott-continuous function between the complete partial order (CPO) (\mathcal{L}, \subseteq) and itself.

Lemma 60 (Finiteness of G) *For any $X \subseteq \mathbb{R}$ and $x \in G(X)$, there exists a finite $Y \subseteq X$ such that $x \in G(Y)$.*

Proof. Let $x \in G(X)$, then there exists $f \in \text{GVAL}_X$ and $t \in X$ such that $x = f(t)$. Then there exists $y_0 \in X^d$ and a polynomial p with coefficients in X such that f satisfies Definition 2. Define Y as the subset of X containing t , the components of y_0 and all the coefficients of p . Then Y is finite and $f \in \text{GVAL}_Y$. Furthermore $t \in Y$ so $x \in G(Y)$. ■

We can now define the set of “generable real numbers”, call it \mathbb{R}_G . The main result of this section is that \mathbb{R}_G is the smallest generable field. But more surprisingly, we show that all the elements of \mathbb{R}_G are polynomial time computable (in the sense of Computable Analysis).

Definition 61 (Generable real numbers)

$$\mathbb{R}_G = \bigcup_{n \geq 0} G^{[n]}(\mathbb{Q}).$$

Theorem 62 (\mathbb{R}_G is generable subfield of \mathbb{R}_P) \mathbb{R}_G is the smallest generable field for inclusion. Furthermore, it form a generable subfield of polynomial time computable real numbers in the sense of Computable Analysis, i.e. $\mathbb{R}_G \subseteq \mathbb{R}_P$.

Proof. First observe that any generable field must contain \mathbb{R}_G . Indeed, let \mathbb{K} be a generable field: then $G(\mathbb{K}) \subseteq \mathbb{K}$ by definition. But G is non-decreasing thus $G(\mathbb{Q}) \subseteq G(\mathbb{K}) \subseteq \mathbb{K}$. By applying G repeatedly, we get that $G^{[n]}(\mathbb{Q}) \subseteq \mathbb{K}$ for all n . Thus $\mathbb{R}_G \subseteq \mathbb{K}$.

Conversely, we need to show that \mathbb{R}_G is a field. Observe that since G is monotone, $G^{[n]}(\mathbb{Q})$ is an increasing sequence (for inclusion). Let $x, y \in \mathbb{R}_G$, then there exists $n \in \mathbb{N}$ such that $x, y \in G^{[n]}(\mathbb{Q})$. Apply Lemma 58 to get that $G^{[n]}(\mathbb{Q})$ is a field. It follows that $x + y, x - y, xy$ and $\frac{x}{y}$ (if $y \neq 0$) belong to $G^{[n]}(\mathbb{Q}) \subseteq \mathbb{R}_G$. Thus \mathbb{R}_G is a field.

It remains to show that \mathbb{R}_G is a *generable* field. This follows from Lemma 60: let $x \in G(\mathbb{R}_G)$, then there exists a **finite** $Y \subseteq \mathbb{R}_G$ such that $x \in G(Y)$. Using the same reasoning as above, there exists $n \in \mathbb{N}$ such that $Y \subseteq G^{[n]}(\mathbb{Q})$. Thus $x \in G(Y) \subseteq G(G^{[n]}(\mathbb{Q})) = G^{[n+1]}(\mathbb{Q}) \subseteq \mathbb{R}_G$. It follows that $G(\mathbb{R}_G) \subseteq \mathbb{R}_G$, i.e. it is generable.

Finally, since $\mathbb{Q} \subseteq \mathbb{R}_P$, iterating Lemma 59 yields that $G^{[n]}(\mathbb{Q}) \subseteq \mathbb{R}_P$ for all $n \in \mathbb{N}$ and thus $\mathbb{R}_G \subseteq \mathbb{R}_P$. ■

Acknowledgments. Daniel Graça was partially supported by *Fundação para a Ciência e a Tecnologia* and EU FEDER POCTI/POCI via SQIG - Instituto de Telecomunicações through the FCT project UID/EEA/50008/2013. Olivier Bournez and Amaury Pouly were partially supported by *DGA Project CALCULS*.



This project has received funding from the European Union’s Horizon 2020 research and innovation programme under the Marie Skłodowska-Curie grant agreement No 731143.

EU disclaimer: the results presented in this paper reflect only the author’s view and the EU is not responsible for any use that may be made of the information it contains.

References

References

[Arn78] V. I. Arnold. *Ordinary Differential Equations*. MIT Press, 1978.

- [BCGH07] O. Bournez, M. L. Campagnolo, D. S. Graça, and E. Hainry. Polynomial differential equations compute all real computable functions on computable compact intervals. *J. Complexity*, 23(3):317–335, 2007.
- [BGP12] Olivier Bournez, Daniel S. Graça, and Amaury Pouly. On the complexity of solving initial value problems. In *37th International Symposium on Symbolic and Algebraic Computation (ISSAC)*, volume abs/1202.4407, 2012.
- [BGP16] O. Bournez, D. S. Graça, and A. Pouly. Computing with polynomial ordinary differential equations. *Journal of Complexity*, 36:106–140, 2016.
- [BHW08] Vasco Brattka, Peter Hertling, and Klaus Weihrauch. *New Computational Paradigms. Changing Conceptions of What is Computable*, chapter A tutorial on computable analysis. Springer-Verlag, New York, 2008.
- [Bus31] V. Bush. The differential analyzer. A new machine for solving differential equations. *J. Franklin Inst.*, 212:447–488, 1931.
- [EM03] L.Hernández Encinas and J.Muñoz Masqué. A short proof of the generalized faà di bruno’s formula. *Applied Mathematics Letters*, 16(6):975 – 979, 2003.
- [GC03] Daniel S. Graça and José Félix Costa. Analog computers and recursive functions over the reals. *Journal of Complexity*, 19(5):644–664, 2003.
- [Gra04] D. S. Graça. Some recent developments on Shannon’s General Purpose Analog Computer. *Math. Log. Quart.*, 50(4-5):473–485, 2004.
- [Gra07] Daniel S. Graça. *Computability with Polynomial Differential Equations*. PhD thesis, Instituto Superior Técnico, 2007.
- [HY88] J.G. Hocking and G.S. Young. *Topology*. Dover Publications Inc, New York, 1988.
- [Ko91] Ker-I Ko. *Complexity Theory of Real Functions*. Progress in Theoretical Computer Science. Birkhäuser, Boston, 1991.
- [KP02] S. G. Krantz and H. R. Parks. *A Primer of Real Analytic Functions*. Birkhäuser, 2nd edition, 2002.
- [Ma09] Tsoy-Wo Ma. Higher chain formula proved by combinatorics. *Electr. J. Comb.*, 16(1), 2009.
- [PE74] M. B. Pour-El. Abstract computability and its relations to the general purpose analog computer. *Trans. Amer. Math. Soc.*, 199:1–28, 1974.
- [PER89] M. B. Pour-El and J. I. Richards. *Computability in Analysis and Physics*. Springer, 1989.

- [Pou15] Amaury Pouly. *Continuous models of computation: from computability to complexity*. PhD thesis, Ecole Polytechnique and Universidade do Algarve, Defended on July 6, 2015. 2015.
- [PZ17] D. Poças and J. Zucker. Analog networks on function data streams. *Computability*, To appear, 2017.
- [Sha41] C. E. Shannon. Mathematical theory of the differential analyser. *Journal of Mathematics and Physics MIT*, 20:337–354, 1941.